



6-Pin DIP Optoisolators

Logic Output

The H11L1 and H11L2 have a gallium arsenide IRED optically coupled to a high-speed integrated detector with Schmitt trigger output. Designed for applications requiring electrical isolation, fast response time, noise immunity and digital logic compatibility.

- Guaranteed Switching Times — $t_{on}, t_{off} < 4 \mu s$
- Built-In On/Off Threshold Hysteresis
- High Data Rate, 1 MHz Typical (NRZ)
- Wide Supply Voltage Capability
- Microprocessor Compatible Drive
- **To order devices that are tested and marked per VDE 0884 requirements, the suffix "V" must be included at end of part number. VDE 0884 is a test option.**

Applications

- Interfacing Computer Terminals to Peripheral Equipment
- Digital Control of Power Supplies
- Line Receiver — Eliminates Noise
- Digital Control of Motors and Other Servo Machine Applications
- Logic to Logic Isolator
- Logic Level Shifter — Couples TTL to CMOS

MAXIMUM RATINGS ($T_A = 25^\circ C$ unless otherwise noted)

Rating	Symbol	Value	Unit
--------	--------	-------	------

INPUT LED

Reverse Voltage	V_R	6	Volts
Forward Current — Continuous — Peak Pulse Width = 300 μs , 2% Duty Cycle	I_F	60 1.2	mA Amp
LED Power Dissipation @ $T_A = 25^\circ C$ Derate above $25^\circ C$	P_D	120 1.41	mW mW/ $^\circ C$

OUTPUT DETECTOR

Output Voltage Range	V_O	0–16	Volts
Supply Voltage Range	V_{CC}	3–16	Volts
Output Current	I_O	50	mA
Detector Power Dissipation @ $T_A = 25^\circ C$ Derate above $25^\circ C$	P_D	150 1.76	mW mW/ $^\circ C$

TOTAL DEVICE

Total Device Dissipation @ $T_A = 25^\circ C$ Derate above $25^\circ C$	P_D	250 2.94	mW mW/ $^\circ C$
Maximum Operating Temperature ⁽²⁾	T_A	–40 to +85	$^\circ C$
Storage Temperature Range ⁽²⁾	T_{stg}	–55 to +150	$^\circ C$
Soldering Temperature (10 s)	T_L	260	$^\circ C$
Isolation Surge Voltage (Pk ac Voltage, 60 Hz, 1 Second Duration) ⁽¹⁾	V_{ISO}	7500	Vac(pk)

1. Isolation surge voltage is an internal device dielectric breakdown rating.
For this test, Pins 1 and 2 are common, and Pins 4, 5 and 6 are common.
 2. Refer to Quality and Reliability Section in Opto Data Book for information on test conditions.
- Preferred** devices are Motorola recommended choices for future use and best overall value.
GlobalOptoisolator is a trademark of Motorola, Inc.

H11L1*

[$I_F(on) = 1.6 \text{ mA Max}$]

H11L2

[$I_F(on) = 10 \text{ mA Max}$]

*Motorola Preferred Device

STYLE 5 PLASTIC

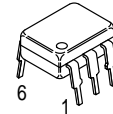

STANDARD THRU HOLE
CASE 730A–04

SCHEMATIC

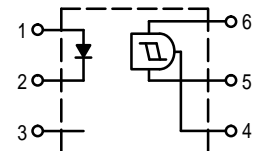

- PIN 1. ANODE
2. CATHODE
3. NC
4. OPEN COLLECTOR
OUTPUT
5. GND
6. VCC

H11L1 H11L2

ELECTRICAL CHARACTERISTICS (T_A = 25°C unless otherwise noted)⁽¹⁾

Characteristic	Symbol	Min	Typ ⁽¹⁾	Max	Unit	
INPUT LED						
Reverse Leakage Current (V _R = 3 V, R _L = 1 MΩ)	I _R	—	0.05	10	μA	
Forward Voltage (I _F = 10 mA) (I _F = 0.3 mA)	V _F	— 0.75	1.2 0.95	1.5 —	Volts	
Capacitance (V _R = 0 V, f = 1 MHz)	C	—	18	—	pF	
OUTPUT DETECTOR						
Operating Voltage	V _{CC}	3	—	15	Volts	
Supply Current (I _F = 0, V _{CC} = 5 V)	I _{CC(off)}	—	1	5	mA	
Output Current, High (I _F = 0, V _{CC} = V _O = 15 V)	I _{OH}	—	—	100	μA	
COUPLED						
Supply Current (I _F = I _{F(on)} , V _{CC} = 5 V)	I _{CC(on)}	—	1.6	5	mA	
Output Voltage, Low (R _L = 270 Ω, V _{CC} = 5 V, I _F = I _{F(on)})	V _{OL}	—	0.2	0.4	Volts	
Threshold Current, ON (R _L = 270 Ω, V _{CC} = 5 V)	I _{F(on)}	— —	1.2 —	1.6 10	mA	
Threshold Current, OFF (R _L = 270 Ω, V _{CC} = 5 V)	I _{F(off)}	0.3 0.3	0.75 —	— —	mA	
Hysteresis Ratio (R _L = 270 Ω, V _{CC} = 5 V)	$\frac{I_{F(off)}}{I_{F(on)}}$	0.5	0.75	0.9		
Isolation Voltage ⁽²⁾ 60 Hz, AC Peak, 1 second, T _A = 25°C	V _{ISO}	7500	—	—	Vac(pk)	
Turn-On Time	R _L = 270 Ω ⁽³⁾ V _{CC} = 5 V, I _F = I _{F(on)} T _A = 25°C	t _{on}	—	1.2	4	μs
Fall Time		t _f	—	0.1	—	
Turn-Off Time		t _{off}	—	1.2	4	
Rise Time		t _r	—	0.1	—	

1. Always design to the specified minimum/maximum electrical limits (where applicable).
2. For this test, IRED Pins 1 and 2 are common and Output Gate Pins 4, 5, 6 are common.
3. R_L value effect on switching time is negligible.

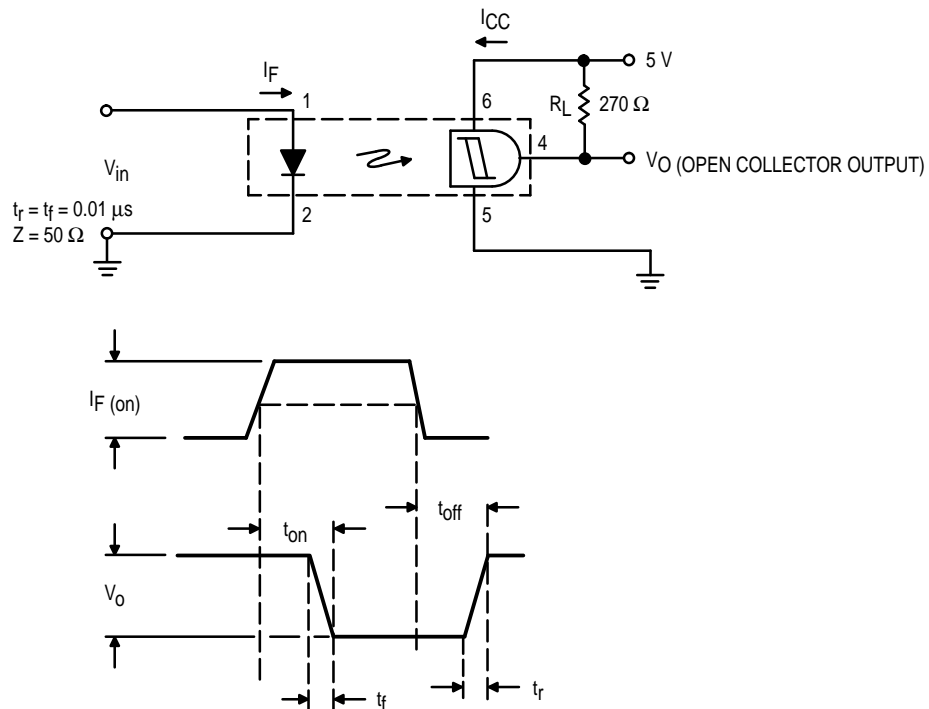

Figure 1. Switching Test Circuit

TYPICAL CHARACTERISTICS

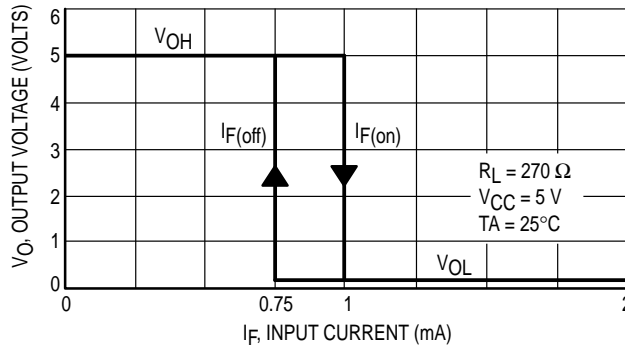

Figure 2. Transfer Characteristics for H11L1

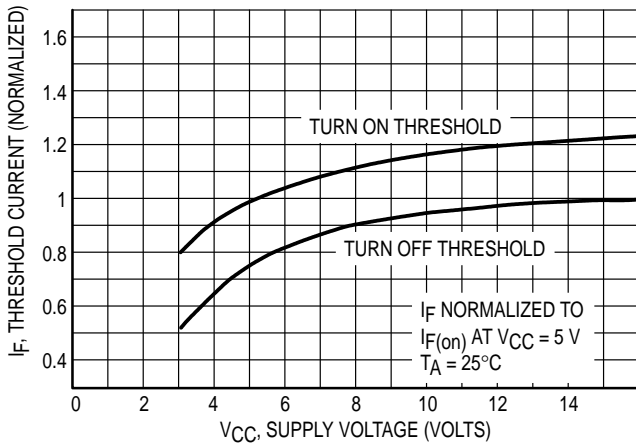

Figure 3. Threshold Current versus Supply Voltage

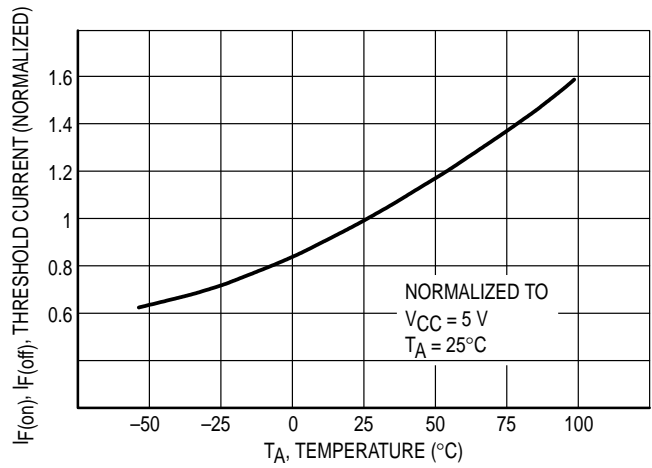

Figure 4. Threshold Current versus Temperature

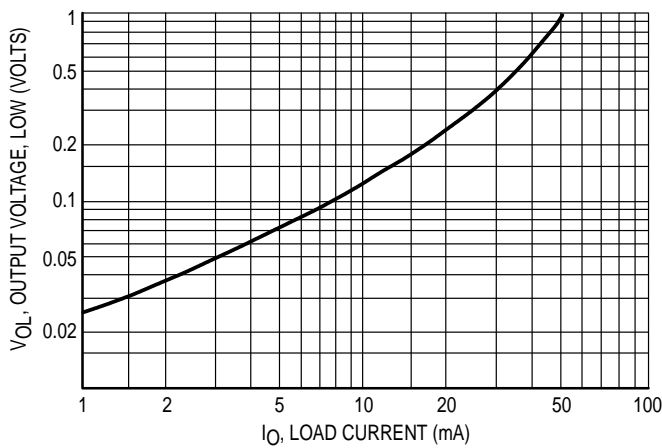

Figure 5. Output Voltage, Low versus Load Current

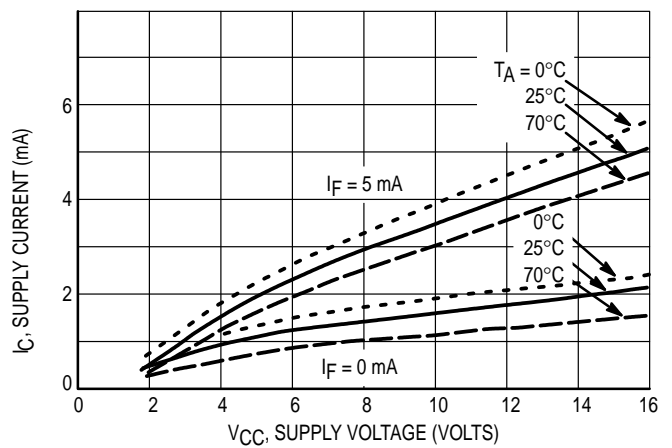
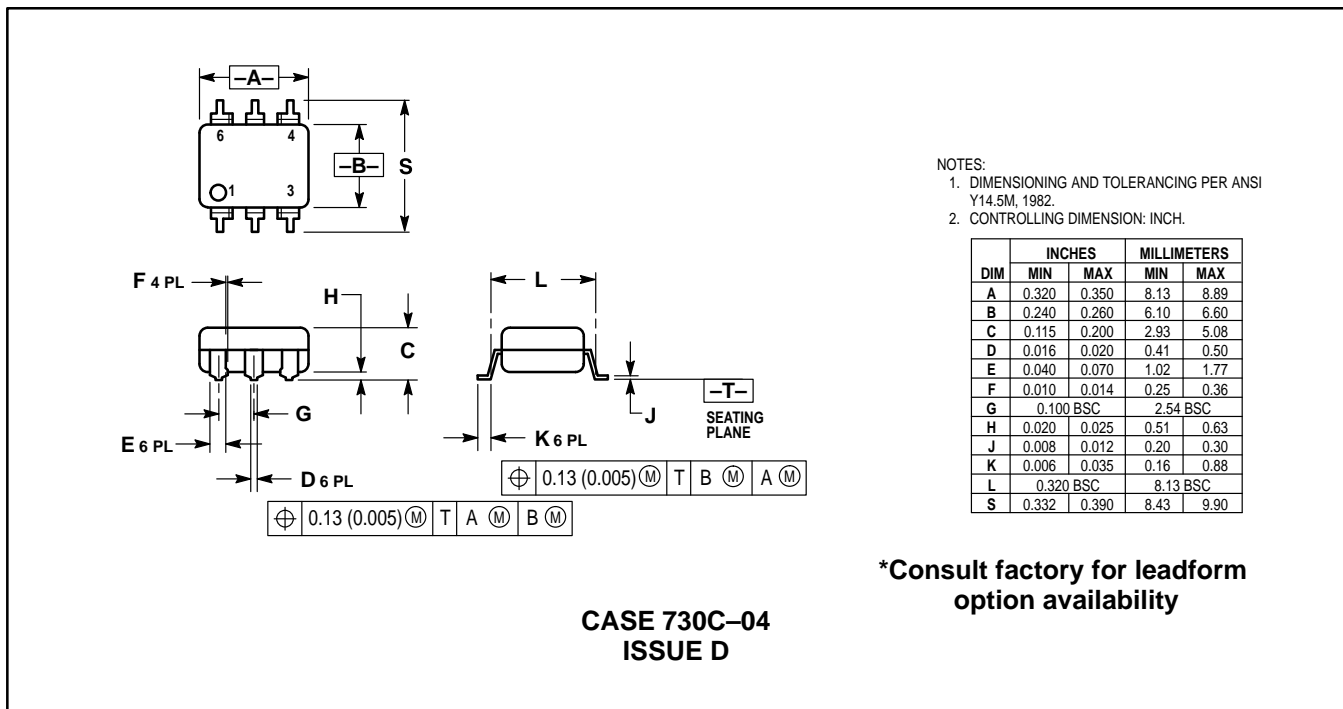
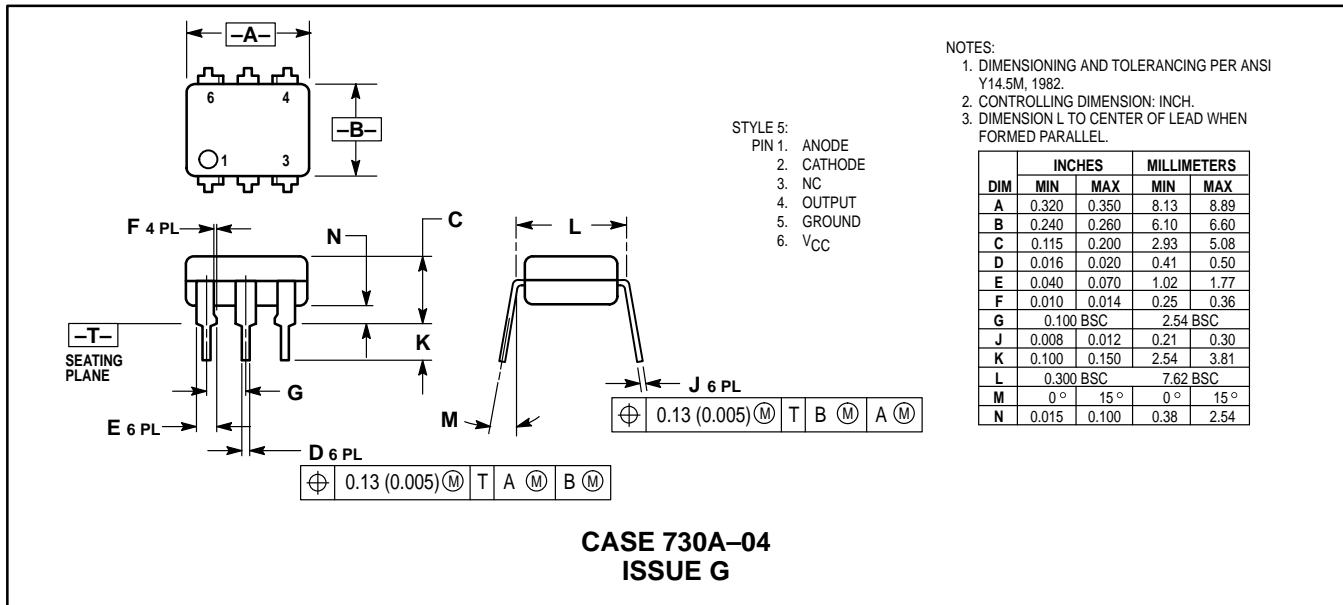
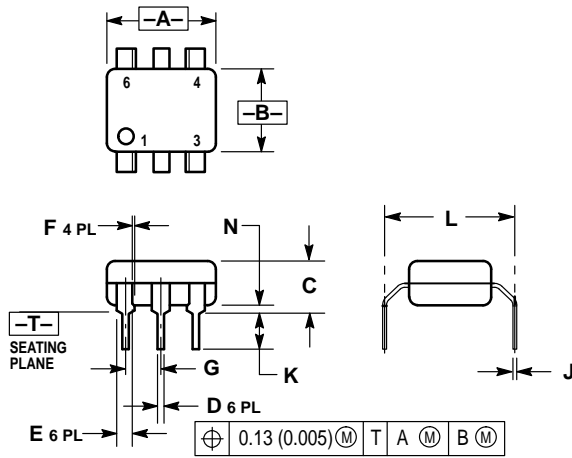

Figure 6. Supply Current versus Supply Voltage

H11L1 H11L2

PACKAGE DIMENSIONS





- NOTES:
1. DIMENSIONING AND TOLERANCING PER ANSI Y14.5M, 1982.
 2. CONTROLLING DIMENSION: INCH.
 3. DIMENSION L TO CENTER OF LEAD WHEN FORMED PARALLEL.

DIM	INCHES		MILLIMETERS	
	MIN	MAX	MIN	MAX
A	0.320	0.350	8.13	8.89
B	0.240	0.260	6.10	6.60
C	0.115	0.200	2.93	5.08
D	0.016	0.020	0.41	0.50
E	0.040	0.070	1.02	1.77
F	0.010	0.014	0.25	0.36
G	0.100 BSC		2.54 BSC	
J	0.008	0.012	0.21	0.30
K	0.100	0.150	2.54	3.81
L	0.400	0.425	10.16	10.80
N	0.015	0.040	0.38	1.02

***Consult factory for leadform option availability**

**CASE 730D-05
ISSUE D**

H11L1 H11L2

Motorola reserves the right to make changes without further notice to any products herein. Motorola makes no warranty, representation or guarantee regarding the suitability of its products for any particular purpose, nor does Motorola assume any liability arising out of the application or use of any product or circuit, and specifically disclaims any and all liability, including without limitation consequential or incidental damages. "Typical" parameters can and do vary in different applications. All operating parameters, including "Typicals" must be validated for each customer application by customer's technical experts. Motorola does not convey any license under its patent rights nor the rights of others. Motorola products are not designed, intended, or authorized for use as components in systems intended for surgical implant into the body, or other applications intended to support or sustain life, or for any other application in which the failure of the Motorola product could create a situation where personal injury or death may occur. Should Buyer purchase or use Motorola products for any such unintended or unauthorized application, Buyer shall indemnify and hold Motorola and its officers, employees, subsidiaries, affiliates, and distributors harmless against all claims, costs, damages, and expenses, and reasonable attorney fees arising out of, directly or indirectly, any claim of personal injury or death associated with such unintended or unauthorized use, even if such claim alleges that Motorola was negligent regarding the design or manufacture of the part. Motorola and  are registered trademarks of Motorola, Inc. Motorola, Inc. is an Equal Opportunity/Affirmative Action Employer.

How to reach us:

USA / EUROPE: Motorola Literature Distribution;
P.O. Box 20912; Phoenix, Arizona 85036. 1-800-441-2447

JAPAN: Nippon Motorola Ltd.; Tatsumi-SPD-JLDC, Toshikatsu Otsuki,
6F Seibu-Butsuryu-Center, 3-14-2 Tatsumi Koto-Ku, Tokyo 135, Japan. 03-3521-8315

MFAX: RMFAX0@email.sps.mot.com – TOUCHTONE (602) 244-6609
INTERNET: <http://Design-NET.com>

HONG KONG: Motorola Semiconductors H.K. Ltd.; 8B Tai Ping Industrial Park,
51 Ting Kok Road, Tai Po, N.T., Hong Kong. 852-26629298



H11L1/D



This datasheet has been download from:

www.datasheetcatalog.com

Datasheets for electronics components.