

MAXIM

12V, Ultra-Low IQ, Low-Dropout Linear Regulators

MAX1725/MAX1726

General Description

The MAX1725/MAX1726 are ultra-low supply current, low-dropout linear regulators intended for low-power applications that demand the longest possible battery life. Unlike inferior PNP-based designs, the MAX1725/MAX1726s' PMOS pass elements maintain an ultra-low 2 μ A supply current throughout their entire operating range and in dropout. Despite their ultra-low power consumption, the MAX1725/MAX1726 have tight output accuracy (1.5%) and require just 1 μ F output capacitance to achieve good load-transient response.

These regulators have a wide input voltage range (+2.5V to +12V), making them excellent choices for systems powered from two lithium-ion (Li+) cells and 9V batteries. Other features include reverse-battery protection, short-circuit protection, and thermal protection.

The MAX1725 provides an adjustable 1.5V to 5V output using an external resistor-divider. The MAX1726 provides factory preset 1.8V, 2.5V, 3.3V, or 5V output voltages (see the *Ordering Information*). Both devices are available in a tiny 5-pin SOT23 package.

Applications

Smoke Detectors
Remote Transmitters
Smart Battery Packs
Industrial Control Systems
Microcontroller Power
Real-Time Clock Backup Power
PDAs and Handy-Terminals
Battery-Powered Alarms

Typical Operating Circuit

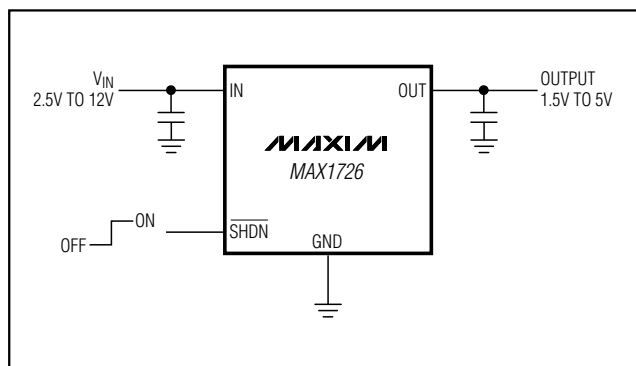

Features

- ◆ 2 μ A Supply Current
- ◆ Reverse-Battery Protection
- ◆ +2.5V to +12V Input Voltage Range
- ◆ Fixed 1.8V, 2.5V, 3.3V, and 5V Output Voltages (MAX1726)
- ◆ Adjustable 1.5V to 5V Output Voltages (MAX1725)
- ◆ 20mA Guaranteed Output Current
- ◆ 1.5% Output Voltage Accuracy
- ◆ Small 1 μ F Output Capacitor
- ◆ Short-Circuit Protection
- ◆ Thermal Protection
- ◆ Tiny 5-Pin SOT23 Package

Ordering Information

PART	TEMP RANGE	PIN-PACKAGE	TOP MARK
MAX1725EUK-T	-40°C to +85°C	5 SOT23-5	ADNK
MAX1726EUK18-T	-40°C to +85°C	5 SOT23-5	ADNL
MAX1726EUK25-T	-40°C to +85°C	5 SOT23-5	ADNM
MAX1726EUK33-T	-40°C to +85°C	5 SOT23-5	ADNN
MAX1726EUK5-T	-40°C to +85°C	5 SOT23-5	ADNO

Note: See the Selector Guide for the MAX1725/MAX1726 output options as they relate to the part number suffix.

Selector Guide

PART	OUTPUT VOLTAGE (V)
MAX1725EUK-T	Adj. 1.5 to 5.0
MAX1726EUK18-T	Fixed 1.8
MAX1726EUK25-T	Fixed 2.5
MAX1726EUK33-T	Fixed 3.3
MAX1726EUK50-T	Fixed 5.0

Pin Configuration appears at end of data sheet.

MAXIM

Maxim Integrated Products 1

For pricing, delivery, and ordering information, please contact Maxim/Dallas Direct! at 1-888-629-4642, or visit Maxim's website at www.maxim-ic.com.

12V, Ultra-Low IQ, Low-Dropout Linear Regulators

ABSOLUTE MAXIMUM RATINGS

IN to GND.....	-14V to +14V	OUT Short Circuit.....	Indefinite
SHDN to GND.....	-0.3V to (V _{IN} + 0.3V)	Continuous Power Dissipation (T _A = +70°C)	5-Pin SOT23-5 (derate 7.1mW/°C above +70°C)571mW
	(-0.3V to +0.3V when V _{IN} < 0V)	θ _{JA}	+140°C/W
OUT, FB (MAX1725 only) to GND.....	-0.3V to +6V when	Junction Temperature	+150°C
	V _{IN} > 5.7V; -0.3V to (V _{IN} + 0.3V) when 0V <	Operating Temperature Range	-40°C to +85°C
	V _{IN} < 5.7V; -0.3V to +0.3V when V _{IN} < 0V	Storage Temperature Range	-65°C to +150°C
OUT Continuous Current.....	200mA	Lead Temperature (soldering, 10s)	+300°C

Stresses beyond those listed under "Absolute Maximum Ratings" may cause permanent damage to the device. These are stress ratings only, and functional operation of the device at these or any other conditions beyond those indicated in the operational sections of the specifications is not implied. Exposure to absolute maximum rating conditions for extended periods may affect device reliability.

ELECTRICAL CHARACTERISTICS

(Circuit of Figure 1, V_{IN} = V_{OUT} + 1V, SHDN = IN, I_{OUT} = 1mA, T_A = -40°C to +85°C, unless otherwise noted. Typical values are at T_A = +25°C.) (Note 1)

PARAMETER	SYMBOL	CONDITIONS	MIN	TYP	MAX	UNITS	
Input Voltage Range	V _{IN}	(Note 2)	2.5		12	V	
Supply Current	I _{IN}	V _{IN} = 12V		2	4.5	μA	
Shutdown Supply Current	I _{IN(SHDN)}	SHDN = 0V, V _{IN} = 12V, V _{OUT} = 0V		0.7	2	μA	
OUT Voltage Range	V _{OUT}	MAX1725 only	1.5		5	V	
FB Voltage	V _{FB}	MAX1725 only (Note 3)		1.245		V	
OUT Voltage Accuracy (Note 3)		T _A = +25°C	-1.5		1.5	%	
		T _A = 0°C to +85°C	-2		+2		
		T _A = -40°C to +85°C	-3		+3		
Line Regulation	ΔV _{LNR}	V _{IN} = 2.5V or (V _{OUT} + 0.5V) to 12V		0.01	0.3	%/V	
Load Regulation	ΔV _{LDR}	I _{OUT} = 1mA to 20mA, V _{IN} = (V _{OUT} + 1V) or 3V (min)		0.015	0.15	%/mA	
Maximum OUT Current	I _{OUT}	V _{IN} = (V _{OUT} + 1V) or 3V (Note 4)	20	80		mA	
Dropout Voltage (Note 4)	ΔV _{DO}	I _{OUT} = 20mA for V _{OUT} ≥ 2.5V, I _{OUT} = 10mA for V _{OUT} < 2.5V, not applicable for V _{OUT} < 1.9V		300	600	mV	
Foldback Current Limit	I _{SC}	V _{IN} = 12V, V _{OUT} = 0V		40		mA	
SHDN Input Threshold	V _{IH}	V _{IN} = 2.5V to 12V	2		0.5	V	
	V _{IL}						
SHDN Input Bias Current	I _{SHDN}	V _{SHDN} = 0V to 12V	T _A = +25°C	-50	+50	nA	
			T _A = +85°C	0.1			
FB Input Bias Current (MAX1725 only)	I _{FB}	V _{FB} = 1.25V	T _A = +25°C	-20	2	+20	nA
			T _A = +85°C	1.5			
IN Reverse Leakage Current		V _{IN} = -12V, V _{SHDN} = 0V		0.01	10	μA	
Thermal-Shutdown Threshold		Temperature rising		150		°C	
Thermal-Shutdown Hysteresis				15		°C	

12V, Ultra-Low IQ, Low-Dropout Linear Regulators

MAX1725/MAX1726

ELECTRICAL CHARACTERISTICS (continued)

(Circuit of Figure 1, $V_{IN} = V_{OUT} + 1V$, $\overline{SHDN} = IN$, $I_{OUT} = 1mA$, $T_A = -40^{\circ}C$ to $+85^{\circ}C$, unless otherwise noted. Typical values are at $T_A = +25^{\circ}C$.) (Note 1)

PARAMETER	SYMBOL	CONDITIONS	MIN	TYP	MAX	UNITS
OUT Line-Transient Overshoot/Undershoot		$\Delta V_{IN} = \pm 0.25V$, $t_R = t_F = 5\mu s$		15		mV
OUT Load-Transient Overshoot/Undershoot		I_{OUT} from 1mA to 10mA, $t_R = t_F = 1\mu s$		200		mV
OUT Noise	e_n	$f = 10Hz$ to $100kHz$		350		μV_{RMS}

Note 1: Limits are 100% production tested at $+25^{\circ}C$. All temperature limits are guaranteed by design.

Note 2: Guaranteed by OUT line-regulation testing.

Note 3: OUT accuracy from nominal voltage. The MAX1725 is tested at $V_{OUT} = 1.5V$, $2.5V$, and $5V$.

Note 4: When V_{OUT} falls to 4% below its value at $V_{IN} = V_{OUT} + 1V$.

Typical Operating Characteristics

($V_{OUT} = +3.3V$, $I_{OUT} = 1mA$, $T_A = +25^{\circ}C$, unless otherwise noted.)

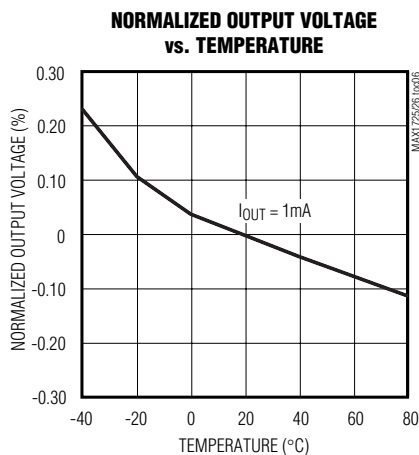
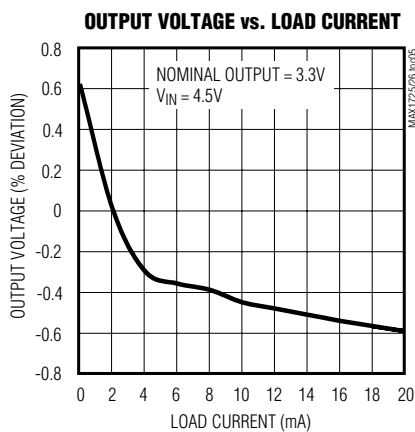
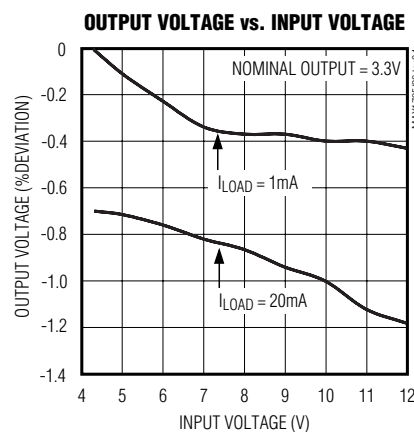
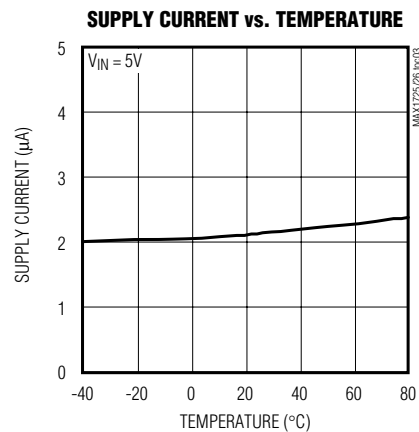
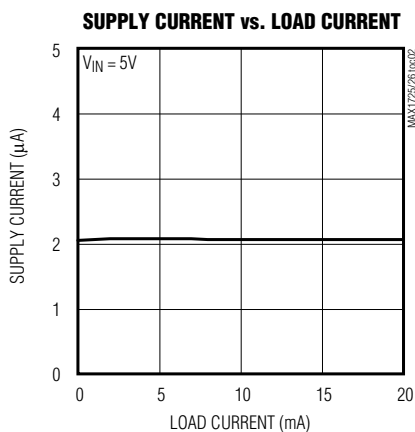
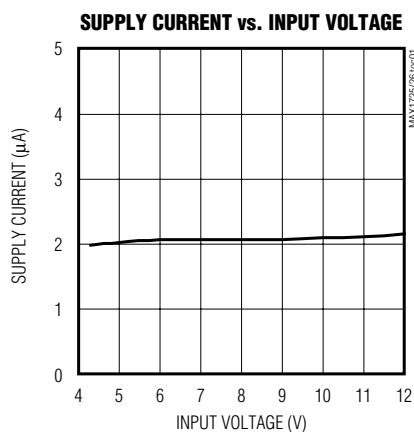

12V, Ultra-Low IQ, Low-Dropout Linear Regulators

Typical Operating Characteristics (continued)

($V_{OUT} = +3.3V$, $I_{OUT} = 1mA$, $T_A = +25^\circ C$, unless otherwise noted.)

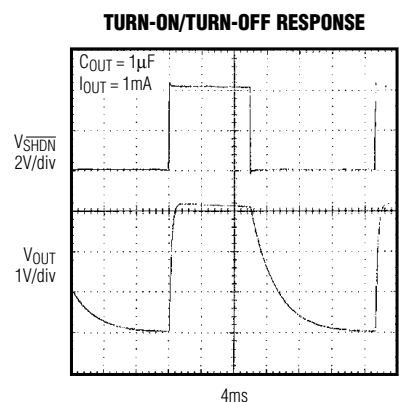
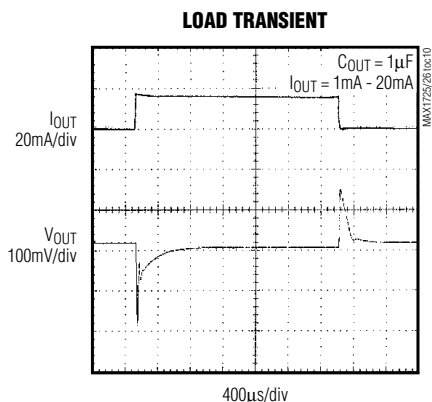
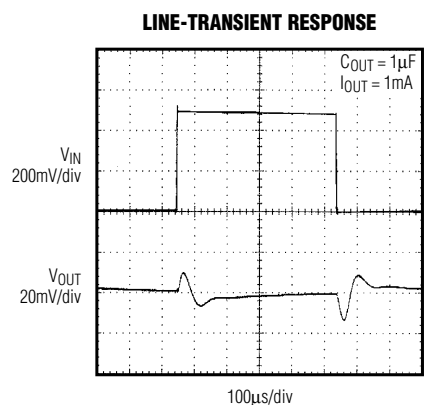
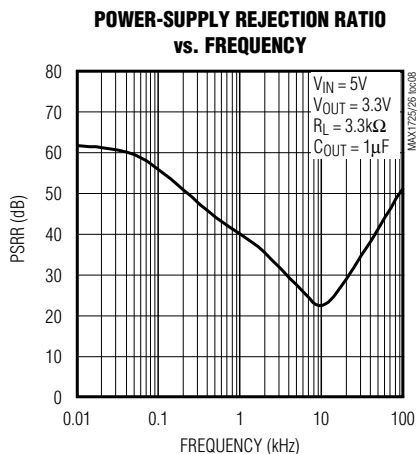
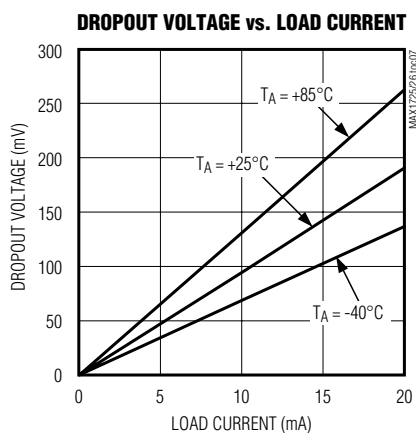

Pin Description

PIN		NAME	FUNCTION
MAX1725	MAX1726		
1	1	IN	Supply Voltage Input
2	2	GND	Ground
3	3	OUT	Voltage Output
4	—	FB	Feedback Voltage Input
—	4	GND	Ground
5	5	\overline{SHDN}	Active-Low Shutdown Input

Detailed Description

The MAX1725/MAX1726 are low-dropout, low-quiescent-current linear regulators designed primarily for battery-powered applications (Figure 1). The MAX1725 provides an adjustable output voltage from 1.5V to 5V using an external resistor-divider. The MAX1726 supplies preset output voltages of 1.8V, 2.5V, 3.3V, or 5V. These devices consist of a +1.245V error amplifier, MOSFET driver, and P-channel pass transistor (Figure 2).

12V, Ultra-Low IQ, Low-Dropout Linear Regulators

The error amplifier compares 1.245V to the selected feedback voltage and amplifies the difference. If the feedback voltage is lower than 1.245V, the pass-transistor gate is pulled lower, allowing more current to pass, and thus increasing the output voltage. If the feedback voltage is higher than 1.245V, the pass-transistor gate is driven higher, allowing less current to

pass to the output. The output voltage is fed back through either an internal resistor voltage-divider connected to OUT (MAX1726) or an external resistor network connected to FB (MAX1725). Additional features include an output current limiter, reverse-battery protection, a thermal sensor, and shutdown logic.

Internal P-Channel Pass Transistor

The MAX1725/MAX1726 feature a P-channel MOSFET pass transistor. This provides advantages over similar designs using PNP pass transistors, including longer battery life. The P-channel MOSFET requires no base drive, which reduces quiescent current considerably. PNP-based regulators waste considerable current in dropout when the pass transistor saturates; they also use high base-drive currents under large loads. The MAX1725/MAX1726 do not suffer from these problems, and consume only 2 μ A of quiescent current throughout their load range (see the *Typical Operating Characteristics*).

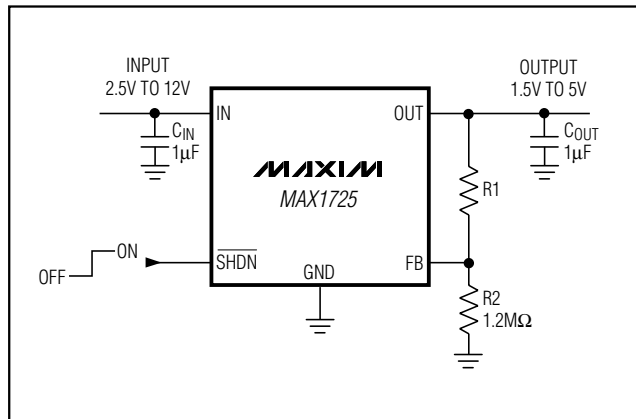

Figure 1. Typical Application Circuit

Shutdown

To enter shutdown, drive the $\overline{\text{SHDN}}$ pin below 0.5V. When the MAX1725/MAX1726 are shut down, the output

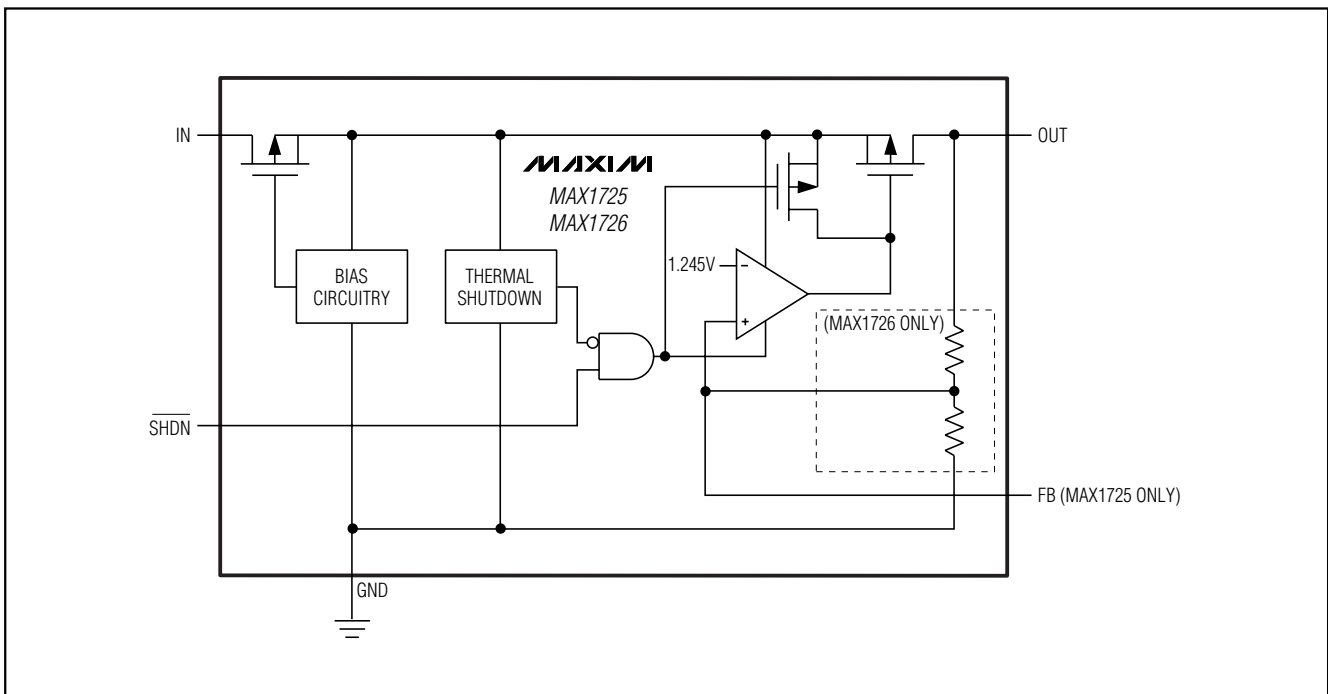

Figure 2. Functional Diagram

12V, Ultra-Low IQ, Low-Dropout Linear Regulators

pass transistor shuts off, the output falls to ground, and supply current drops from 2 μ A to 0.7 μ A. Connect SHDN to IN for normal operation. If reverse-battery protection is needed, drive SHDN through a 100k Ω resistor.

Thermal-Overload Protection

Thermal-overload protection limits total power dissipation in the MAX1725/MAX1726. When the junction temperature exceeds $T_J = +150^\circ\text{C}$, the thermal sensor signals the shutdown logic, turning off the pass transistor and allowing the IC to cool. The thermal sensor turns the pass transistor on again after the IC's junction temperature cools by 15 $^\circ\text{C}$, resulting in a pulsed output during continuous thermal-overload conditions.

Thermal-overload protection is designed to protect the devices in the event of fault conditions. For continuous operation, do not exceed the absolute maximum junction temperature rating of $T_J = +150^\circ\text{C}$.

Foldback Current Limiting

The MAX1725/MAX1726 also include a foldback current limiter. When the output is shorted to ground, the output PMOS drive is limited so that the output current does not exceed 40mA (typ). The output can be shorted to ground indefinitely without damaging the part.

Reverse-Battery Protection

The MAX1725/MAX1726 have a unique protection scheme that limits the reverse supply current to less than 10 μ A when V_{IN} is forced below ground. The circuitry monitors the polarity of the input, disconnecting the internal circuitry and parasitic diodes when the battery is reversed. This feature prevents the device, battery, and load from overheating and electrical stress. For reverse-battery protection, drive SHDN through a 100k Ω resistor.

Applications Information

Capacitor Selection and Regulator Stability

For general purposes, use a 1 μ F capacitor on the MAX1725/MAX1726 input and output. Larger input capacitor values and lower ESR provide better supply-noise rejection and transient response. A higher-value input capacitor (10 μ F) may be necessary if large, fast transients are anticipated and the device is located several inches from the power source. For stable operation over the full temperature range, use a minimum of 1 μ F on the output.

Output Voltage Selection

For fixed 1.8V, 2.5V, 3.3V, or 5V output voltages, use the MAX1726.

The MAX1725 features an adjustable output voltage from 1.5V to 5V, using two external resistors connected as a voltage-divider to FB (Figure 1). The MAX1725 is optimized for operation with $R_2 = 1.2\text{M}\Omega$. The output voltage is set by the following equation:

$$V_{\text{OUT}} = V_{\text{FB}} \left(1 + \frac{R_1}{R_2} \right)$$

where typically $V_{\text{FB}} = 1.245\text{V}$. To simplify resistor selection:

$$R_1 = R_2 \left(\frac{V_{\text{OUT}}}{V_{\text{FB}}} - 1 \right)$$

Choose $R_2 = 1.2\text{M}\Omega$ for best accuracy.

Power-Supply Rejection and Operation from Sources Other than Batteries

The MAX1725/MAX1726 are designed to deliver low dropout voltages and low quiescent currents in battery-powered systems. Power-supply rejection is 60dB at low frequencies and rolls off above 100Hz. At high frequencies, the output capacitor is the major contributor to the rejection of power-supply noise (see the Power-Supply Rejection Ratio vs. Frequency graph in the *Typical Operating Characteristics*).

When operating from sources other than batteries, improve supply-noise rejection and transient response by increasing the value of the input and output capacitors, and by using passive filtering techniques (see the Supply and Load Transient Response graph in the *Typical Operating Characteristics*).

Chip Information

TRANSISTOR COUNT: 112

Pin Configuration

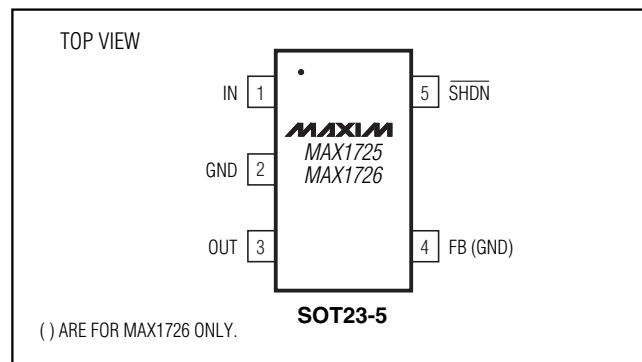

12V, Ultra-Low IQ, Low-Dropout Linear Regulators

Package Information

(The package drawing(s) in this data sheet may not reflect the most current specifications. For the latest package outline information, go to www.maxim-ic.com/packages.)

MAX1725/MAX1726

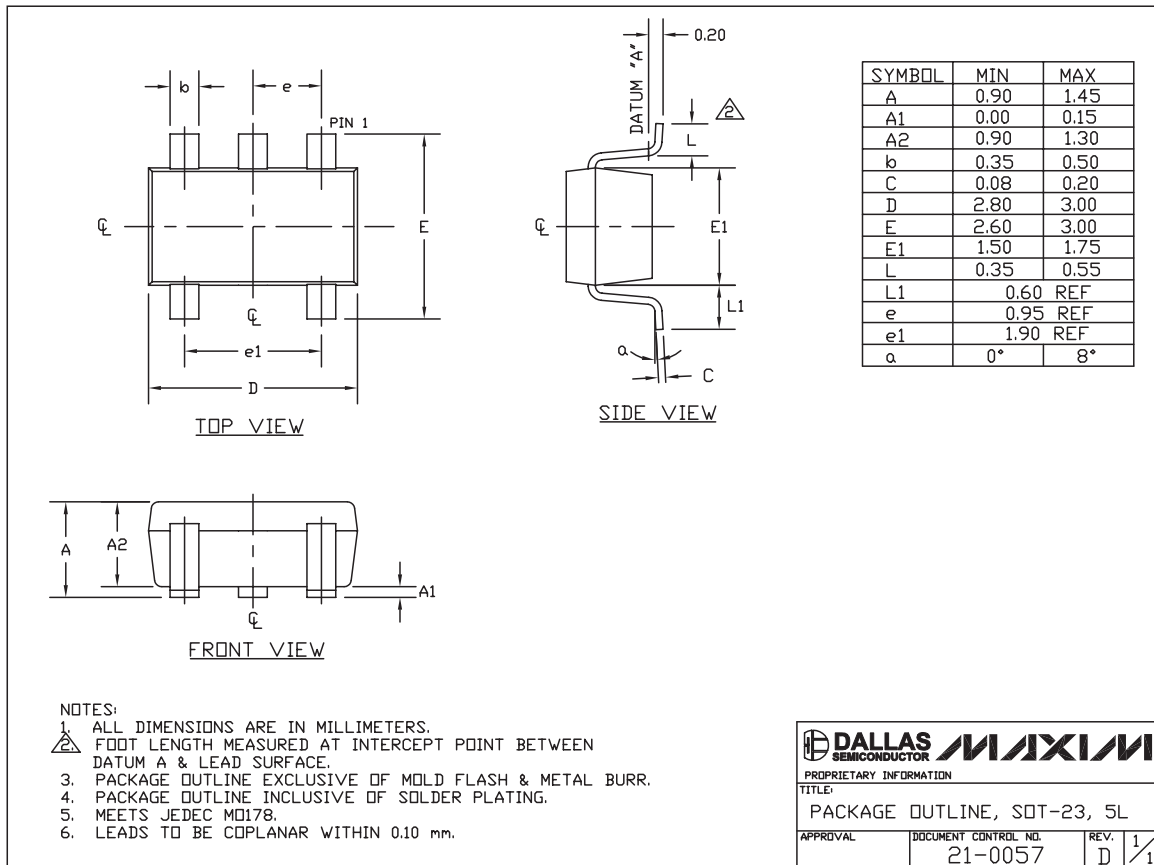

Maxim cannot assume responsibility for use of any circuitry other than circuitry entirely embodied in a Maxim product. No circuit patent licenses are implied. Maxim reserves the right to change the circuitry and specifications without notice at any time.

Maxim Integrated Products, 120 San Gabriel Drive, Sunnyvale, CA 94086 408-737-7600 _____ 7

This datasheet has been download from:

www.datasheetcatalog.com

Datasheets for electronics components.