

Troubleshooting and Repairing LCD TVs

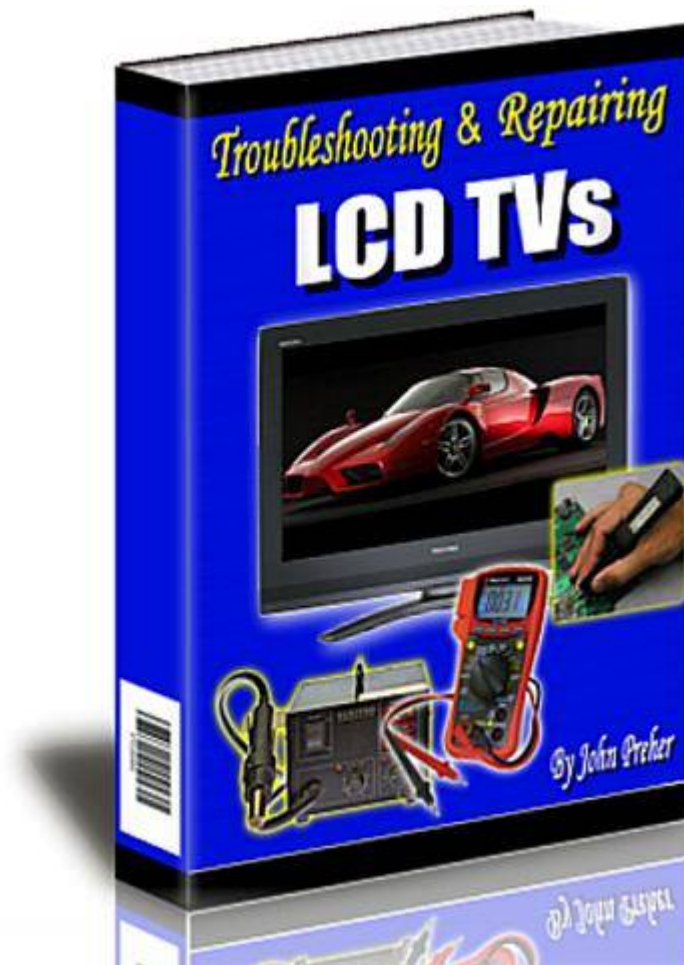

By John Preher

www.preher-tech.com

Copyright

No part of this publication may be reproduced, stored in a retrieval system or transmitted in any form or by any means, electronic, mechanical, photocopying, recording, scanning or otherwise, except as permitted under Sections 107 or 108 of the 1976 United States Copyright Act, without the prior written permission of the publisher or author.

Limit of Liability/Disclaimer of Warranty

The publisher and the author make no representations or warranties with respect to the accuracy or completeness of the contents of this work and specifically disclaim all warranties, including without limitation warranties of fitness for a particular purpose. No warranty may be created or extended by sales or promotional materials. The advice and strategies contained herein may not be suitable for every situation. This work is sold with the understanding that the publisher is not engaged in rendering legal, accounting, or other professional services. If professional assistance is required, the services of a competent professional person should be sought. Neither the publisher nor the author shall be liable for damages arising here from. The fact that an organization or Website is referred to in this work as a citation and/or a potential source of further information does not mean that the author or the publisher endorses the information the organization or Website may provide or recommendations it may make. Further, readers should be aware that Internet Websites listed in this work may have changed or disappeared between when this work was written and when it is read.

For general information on our other products and services or to obtain technical support, please email our Customer Care Department contactus@preher-tech.com

Dedication

This book is dedicated to my wife Lindsay , my daughter Alana and my son Kobin. With out the support of my wonderful family this book would have never been possible.

I would also like to dedicate this book to Jestine Yong, Author and electronics technician. Thank you for all your support and inspiration.

Contents

Liquid Crystals....	6
Liquid Crystal Displays....	10
The Power Supply Board....	15
The Inverter Board....	22
The Main Board....	26
The Controller/T-Con Board....	34
The LCD Driver Board....	35
The Standby Circuit....	36
The Liquid Crystal Display In Depth....	37
Tools....	41
Test Equipment....	50
Schematic Diagrams....	58
Understanding and Testing Resistors....	59
Understanding and Testing Capacitors....	63
Understanding and Testing Inductors....	73
Understanding and Testing Transistors....	77
Understanding and Testing Diodes....	90
Understanding and Testing Bridge Rectifiers....	103
Understanding and Testing LEDs....	110
Understanding and Testing Switching Transformers....	113
Understanding and Testing Opto-Isolators....	117
Understanding and Testing Voltage Regulators....	123
Understanding and Testing Switches....	126
Understanding and Testing Fuses....	128
Some Testing Tips....	131
Useful Formulas....	132
How To Disassemble An LCD TV....	133
Voltage Test Points....	136
The Tap Test....	144
Freeze Spray and Hair Dryers....	146
Connection Problems....	149
PSU (Power Supply Unit) Failures....	152

Inverter Board Failures....	158
Main Board Failures....	163
No Video....	169
No Audio....	171
OSD/Menu Failure....	172
White Screen....	173
Rainbow Screen....	175
Screen Flashes Then TV Shuts Down....	176
No Back light....	177
Lines In Picture....	178
Cracked Panel....	179
LCD TV Repair Case Histories....	180
Safety....	186
Conclusion....	190
Further Reading....	191
Websites....	194
Parts Distributors....	195

Liquid Crystals

Liquid crystals are a type of matter that possess properties between those of standard liquid and those that are more like solid crystal. Liquid crystal may flow like a liquid but at the molecular level it is oriented in a way that normally represents a solid crystal.

Liquid crystals molecules are rod like and can be aligned when electricity is applied to them.

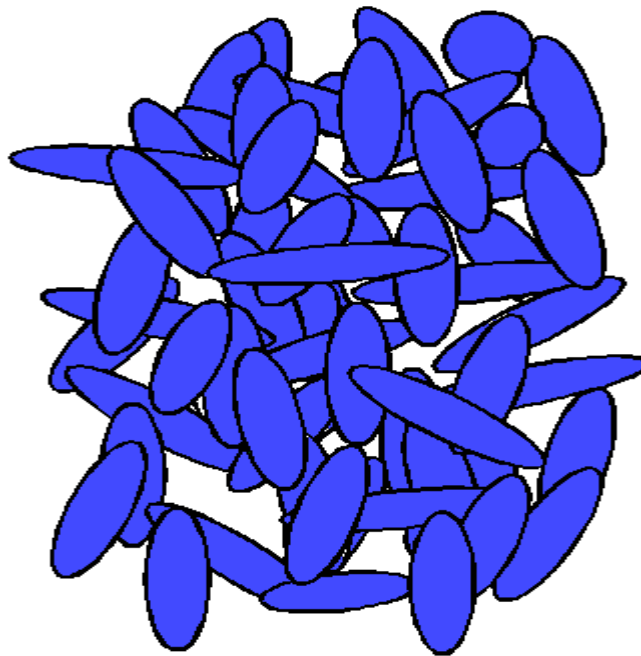

Liquid Crystals

Each sub-pixel or cell of an LCD panel is made up of liquid crystal molecules suspended between two transparent electrodes and two polarizing filters. The axis of polarity for the two filters are perpendicular to each other, so without the liquid crystals between them light passing through one of the filters would be blocked by the next.

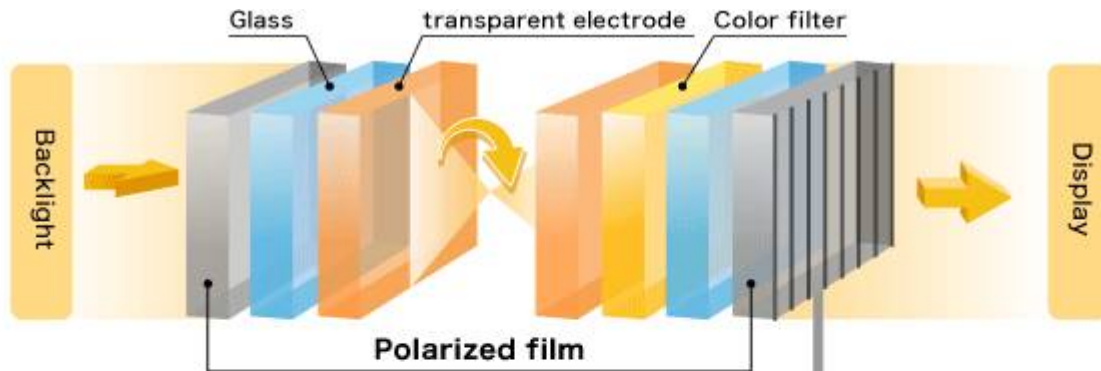

4. Polarized Film Structure

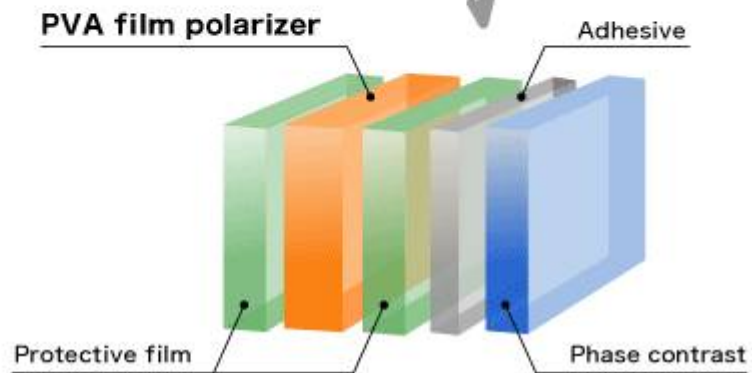

Make up of an LCD panel

Before an electrical current is applied the molecules are in a “relaxed” state. When voltage is applied the molecules align themselves with the electrodes. The electrodes are treated in a manner that causes the crystals to align in a helical structure. This type is called Twisted Nematic (TN) and is one of the most common types in LCD TVs.

Twisted nematic (TN)

Twisted nematic displays contain liquid crystal elements which twist and untwist at varying degrees allowing light to pass through. When no voltage is applied to a TN liquid crystal cell, the light is polarized to pass through the cell. In proportion to the voltage applied, the LC cells twist up to 90 degrees changing the polarization and blocking the light's path. By properly adjusting the level of the voltage almost any gray level or transmission can be achieved.

Other Types Include,

In-plane switching (IPS)

In-plane switching is an LCD technology which aligns the liquid crystal cells in a horizontal direction. In this method, the electrical field is applied through each end of the crystal, but this requires two transistors for each cell instead of the single transistor needed for a standard thin-film transistor (TFT) display. This results in blocking more transmission area, which requires a brighter back light, which usually consumes more power.

Advanced fringe field switching (AFFS)

Advanced fringe field switching is a similar technology to IPS or S-IPS offering superior performance and color, besides high luminosity.

Light passing through an LCD panels first polarizing filter is rotated as it passes through the liquid crystal, allowing it to pass through the second polarizing filter.

When no voltage is applied to the molecules in the helical (TN) structure, they will untwist so as to not rotate light passing through them from the first filter, this will cause the second polarizing filter to block this light.

Liquid Crystal Displays

A liquid crystal display contains a light source/back lighting, a liquid crystal panel and circuits that drive the panel.

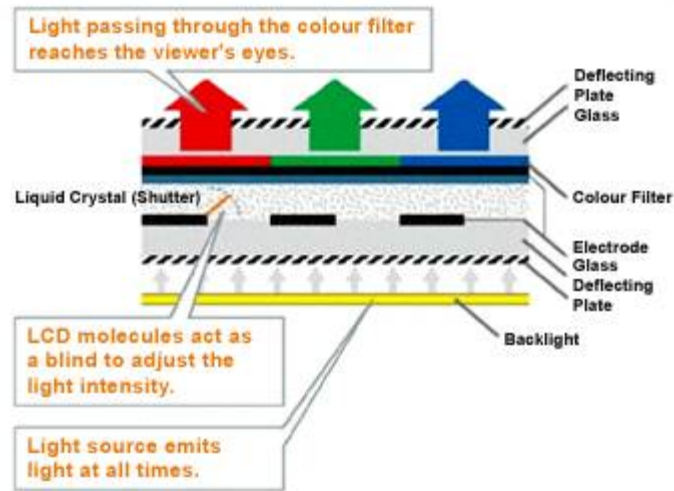

LCD Display

Back lighting

The light source is found at the very rear of the display and it contains a group of thin CCFLs or Cold Cathode Fluorescent Lamps.

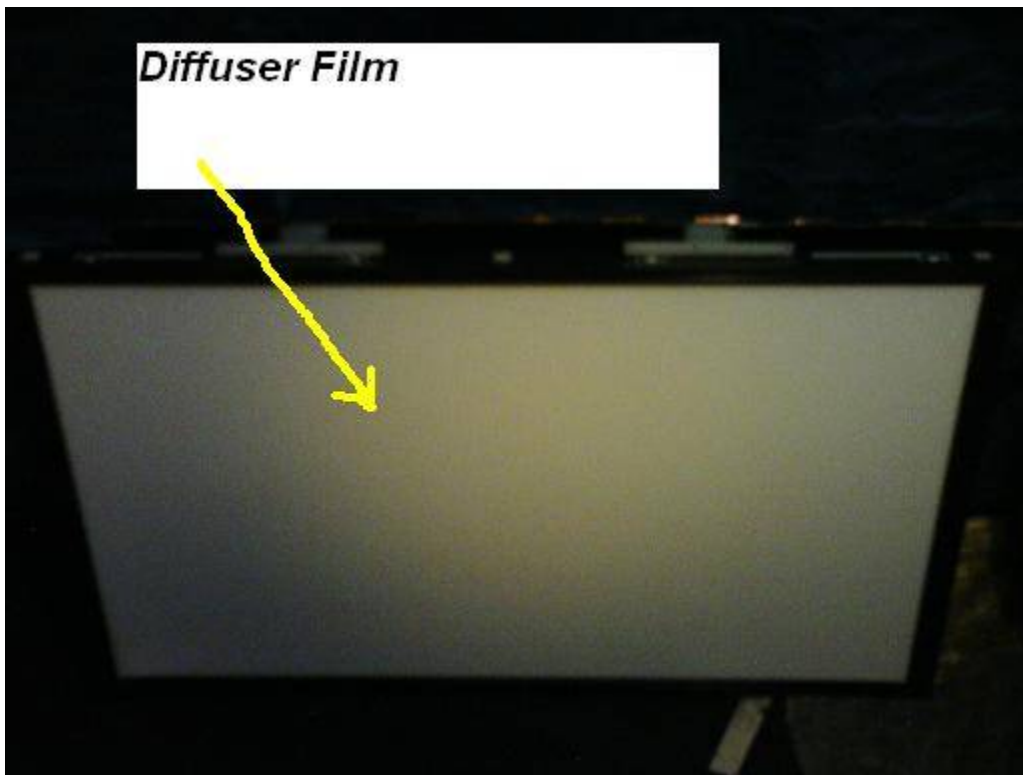

Back light found in LCD TV

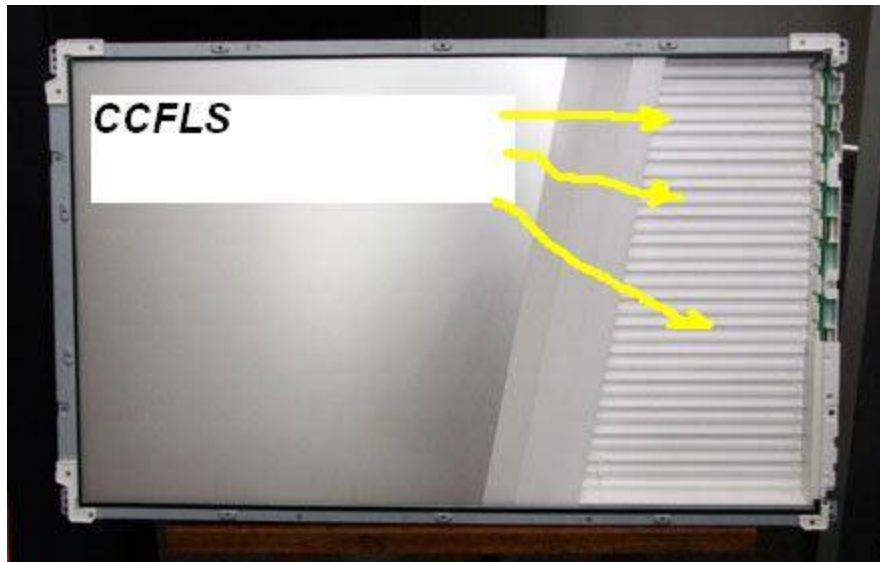

CCFLs used in LCD TV back lighting

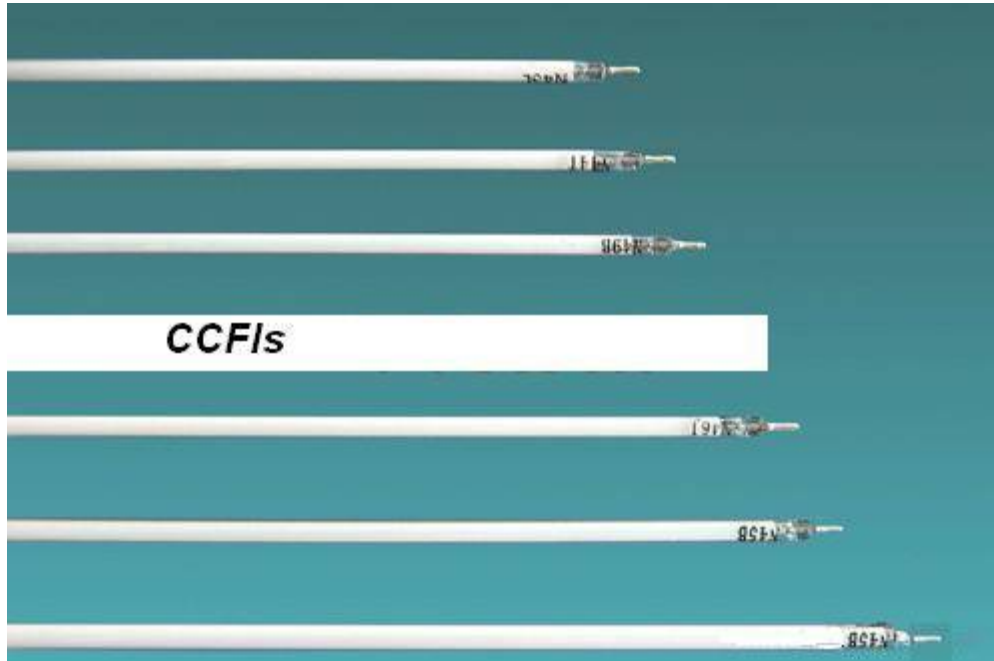

Various CCFLs

The light from the back light passes through diffusers to make sure that the light distribution across the display is uniform. Note that some newer TVs use LED back or side lighting and do not have a large bulky back light and do not require an inverter board. Next the light passes through the LCD panel which is made up of millions of cells. As stated earlier the cells will control the flow of light through the display to create full color images.

The LCD Panel



The LCD Panel Contains Multiple Layers. First a polarizing filter followed by the color filters, TFT sheet, Liquid crystal and then a second polarizing filter (the order can be slightly different depending on manufacturer and panel type).

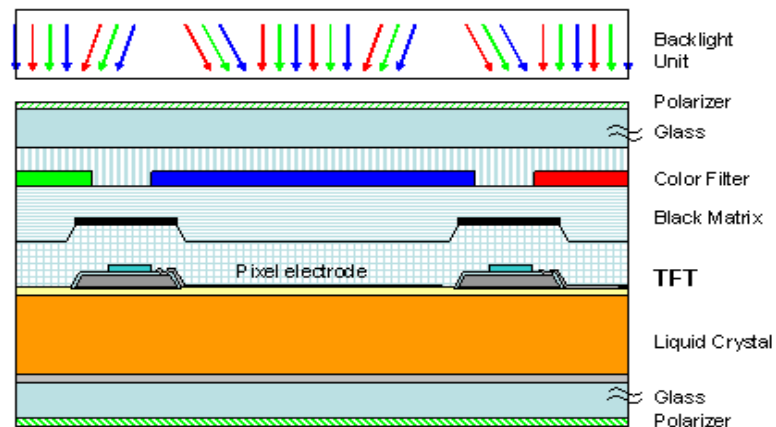

As we just said the LCD panel contains millions of cells (depending on the screen size) and three cells make up a pixel. Each cell is colored either red green or blue. A complete pixel is made up of one green, one red and one blue cell. Each cell is controlled by a TFT or Thin Film Transistor that provides accurate control of each cell and makes for a clear picture.

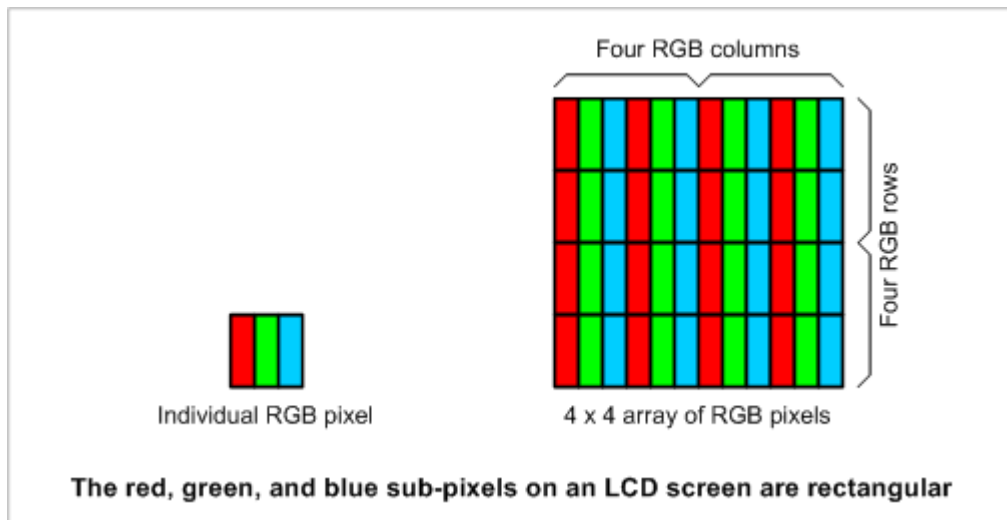

Close look at pixels and cells (sub-pixels)

The Power Supply Board

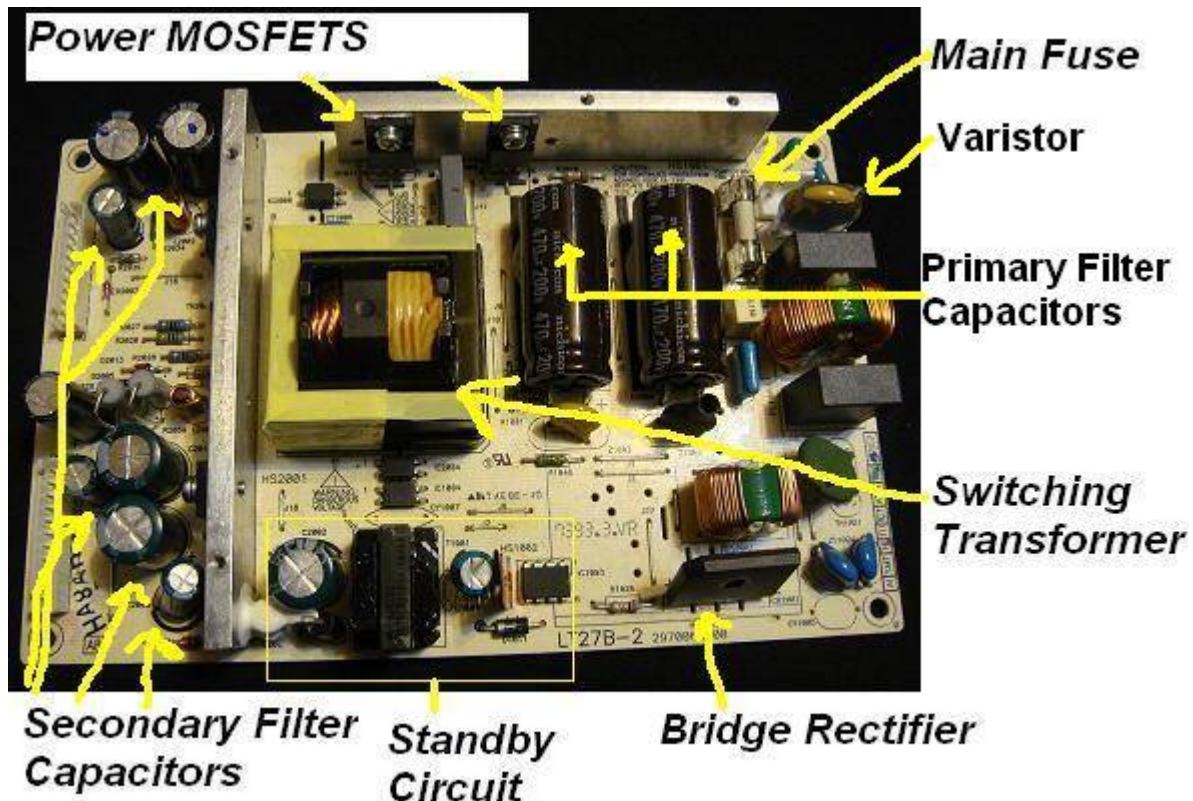

Typical LCD TV PSU (Power Supply Unit)

LCD TVs Use a switching type power supply also known as an SMPS or Switch Mode Power Supply. The power supply converts the mains AC supply into DC (Direct Current) voltages that can be used by the circuits within the LCD TV.

AC (Alternating Current) at the mains voltage (usually 110-120V in USA) enters the PSU and first passes through EMI (Electromagnetic Interference) filtering, inrush current limiting and PFC (Power Factor Correction) circuits. Then the AC voltage is rectified by the bridge rectifier. Note if Active PFC is used, the active PFC circuit will be located after the bridge rectifier and before the reservoir capacitor.

Passive PFC Described

The simplest way to control harmonic current is to use a filter, filters are designed that pass current only at line frequency (50z or 60 Hz). This filter reduces the harmonic current, which means that the non-linear device now looks like a linear load. At this point the power factor can be brought to near unity(1), using capacitors or inductors as required. This filter requires large value high current inductors, which are bulky and expensive. Passive PFC needs an inductor larger than the inductor in an active PFC, but costs less.

Active PFC Described

Active power factor correction (active PFC) uses a more complex electronic circuit to control the amount of power drawn by a load in order to obtain a power factor as close as possible to unity(1). Usually the active PFC circuit controls the input current of the load so that the current waveform is proportional to the mains voltage waveform (a sine wave). The purpose of making the power factor as close to unity(1) as possible is to make the circuit that is power factor corrected appear purely resistive. In this case the voltage and current are in phase and the reactive power consumption is zero. This allows the most efficient delivery of electrical power from the power company to the consumer. Some types of active PFC are Boost,Buck and Buck-boost. Active power factor correction circuits can be single stage or multistage. In the case of a SMPS, a boost converter is inserted between the bridge rectifier and the main input capacitors. The boost converter attempts to maintain a constant DC bus voltage on its output while drawing a current that is constantly in phase with and at the same frequency as the line voltage.

The AC voltage Is now Rectified , output from the Bridge rectifier is a pulsed DC voltage which is then “smoothed” by the reservoir capacitor also called the primary side filter capacitor.

Now let's talk about the power MOSFET/s. In LCD TVs you will commonly find two power MOSFETs in the typical half bridge topology.

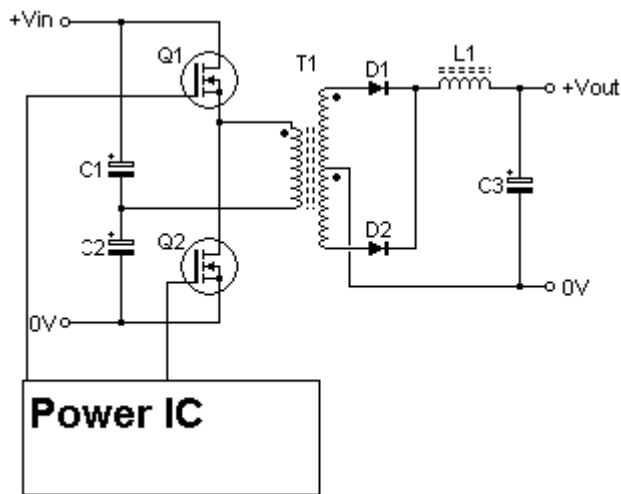

Basic Half Bridge Topology

The MOSFET is a switch in the SMPS, it is turned on by the power IC that sends a square wave pulsed voltage to the gates of the power MOSFETs in the half bridge, turning them on and off alternately at a high frequency. When the first of the power MOSFETs(Q1) is turned on it allows the smoothed DC voltage to flow through the primary winding of the switching transformer to the center of the voltage divider formed by C1 and C2 . When this MOSFET switches off the second MOSFET(Q2) is switched on and the flow of current reverses, going from the center of the voltage divider to ground through the second MOSFET and then the process repeats. This action induces a voltage in the secondary windings of the switching transformer, which steps down the voltage in this case, to AC voltages which are then again rectified by either ultra fast recovery or schottky diodes, then filtered by secondary side filter capacitors and inductors also called chokes because they inhibit or “choke” high frequency changes in current. Now the rectified and smoothed secondary voltages can then be further regulated by voltage regulators or regulation circuits found on other circuits or on the secondary side of the PSU as well. Please note that not all LCD TVs will use the half bridge topology. Some will only have one power MOSFET or FET and some will have the power IC and MOSFET/s integrated into a single package. Most SMPS in LCD TVs you encounter will be fairly similar and will all be SMPS, with a little studying you will see you will find how different ones you encounter work because they will be based on the same principles.



Bottom of PSU showing SMD power IC/half bridge driver

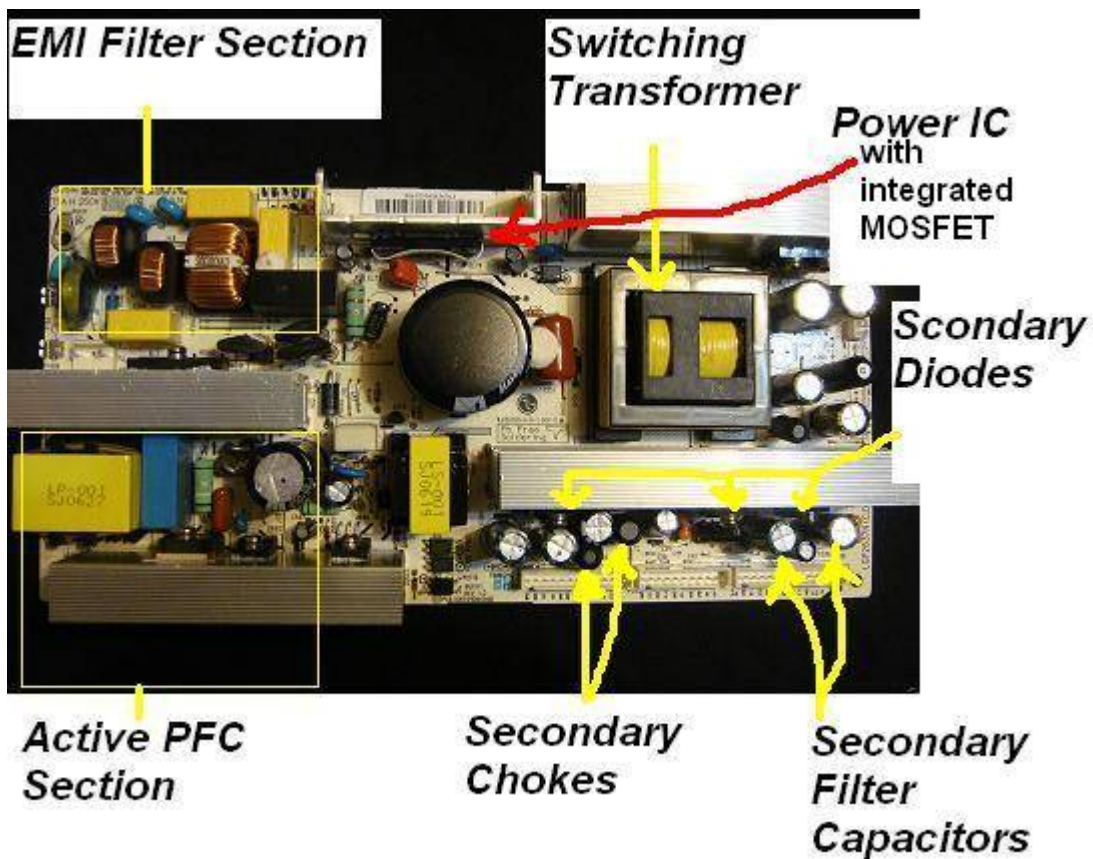

PSU with active PFC

The output of the PSU is kept stable by utilizing feedback. At least one of the secondary voltages must be monitored, this is done by a few circuits. First the sampling circuit which is normally made up of a few resistors. The voltage from the sampling circuit is then taken to an adjustable shunt regulator IC, this is the error detection circuit which monitors the sampled voltage taken from the sampling circuit and then drives an opto-isolator which has an output signal that is amplified and then taken to the power ICs feedback pin so that the power IC can then alter the mark to space ratio of the square wave signal to the MOSFET/s causing a regulation of the output voltage increasing or decreasing the output or even shutting down the TV depending on the signal received from the opto-isolator. This process is called Pulse Width Modulation or PWM. The power IC is sometimes referred to as the PWM(Pulse Width Modulator). If the load on the power supply causes the secondary voltages to drop then the power IC increases the MOSFET/s drive signals duty cycle or you could say the ratio of marks to spaces increases.

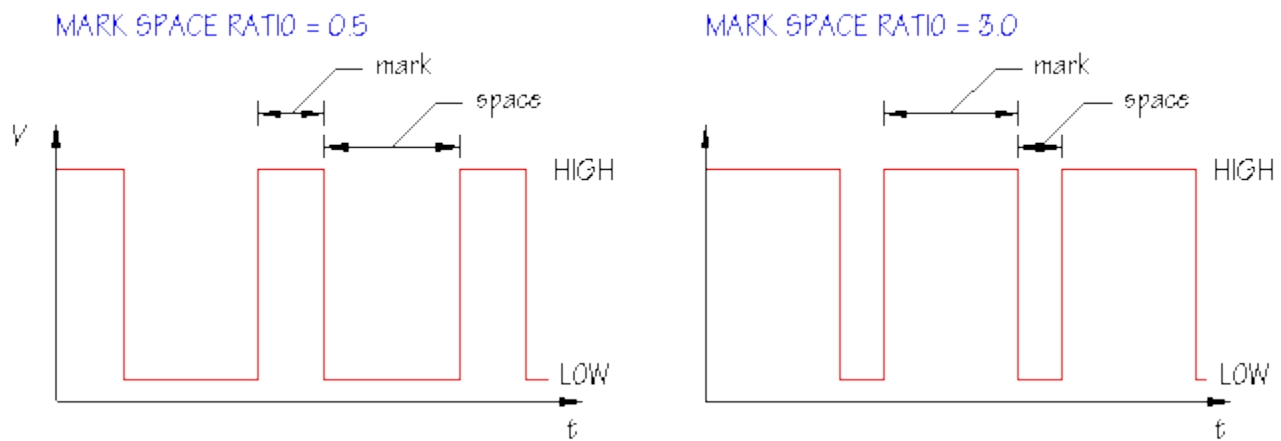

Mark to space ratio

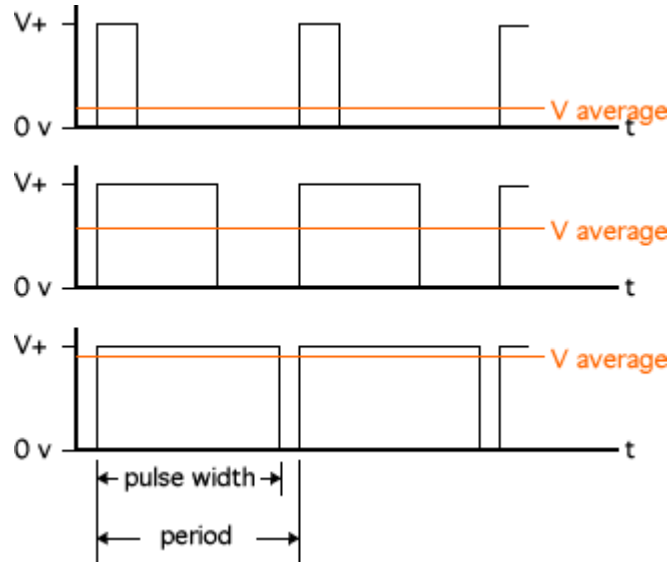

PWM

Some PSUs will use a different type of feed back implementing a secondary winding on the primary side that is used for feedback, still the over all principle is the same and the process is still PWM.

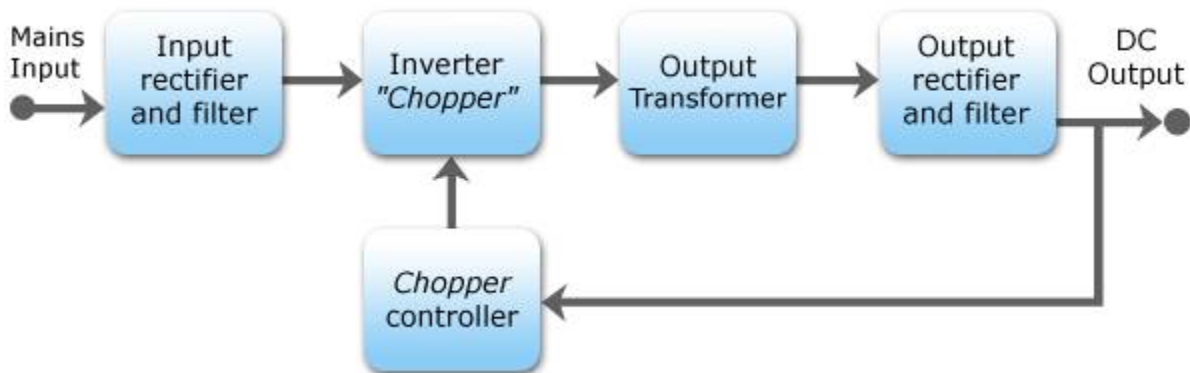

Basic SMPS Block Diagram

To go completely In depth into the workings of the SMPS is beyond the scope of this book, but you should now have a good idea of how an SMPS in an LCD TV works.

I do suggest you read more on SMPS and how to repair them because it will definitely speed up your troubleshooting time. We will go over the SMPS much more in this book but I would still like to recommend you read “[Troubleshooting and Repairing Switch Mode Power Supplies](#)” By Jestine Yong.

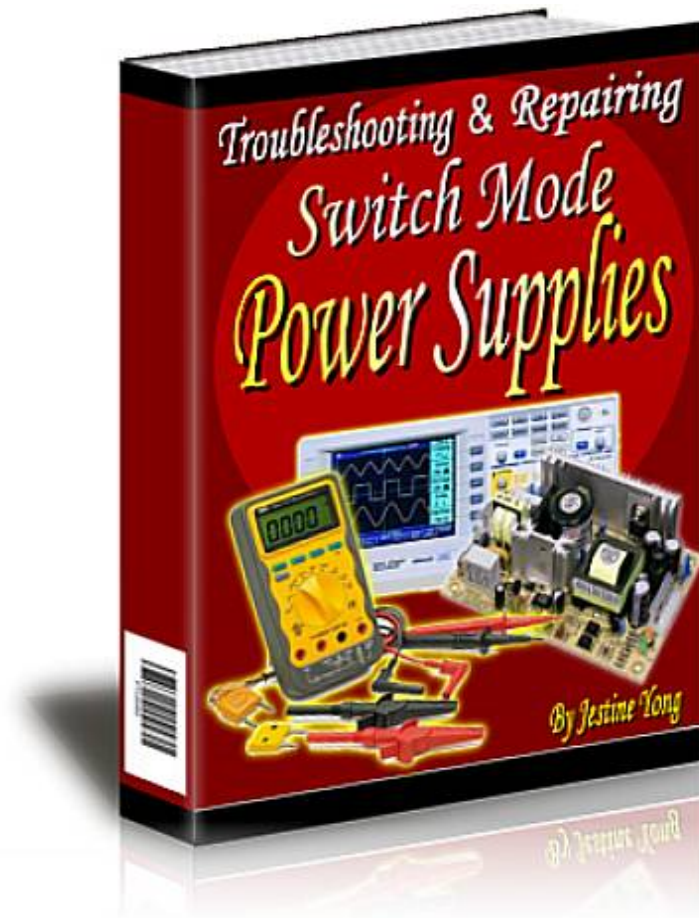

This book is packed with all you need to know to completely understand how to troubleshoot SMPS quickly.

The Inverter Board

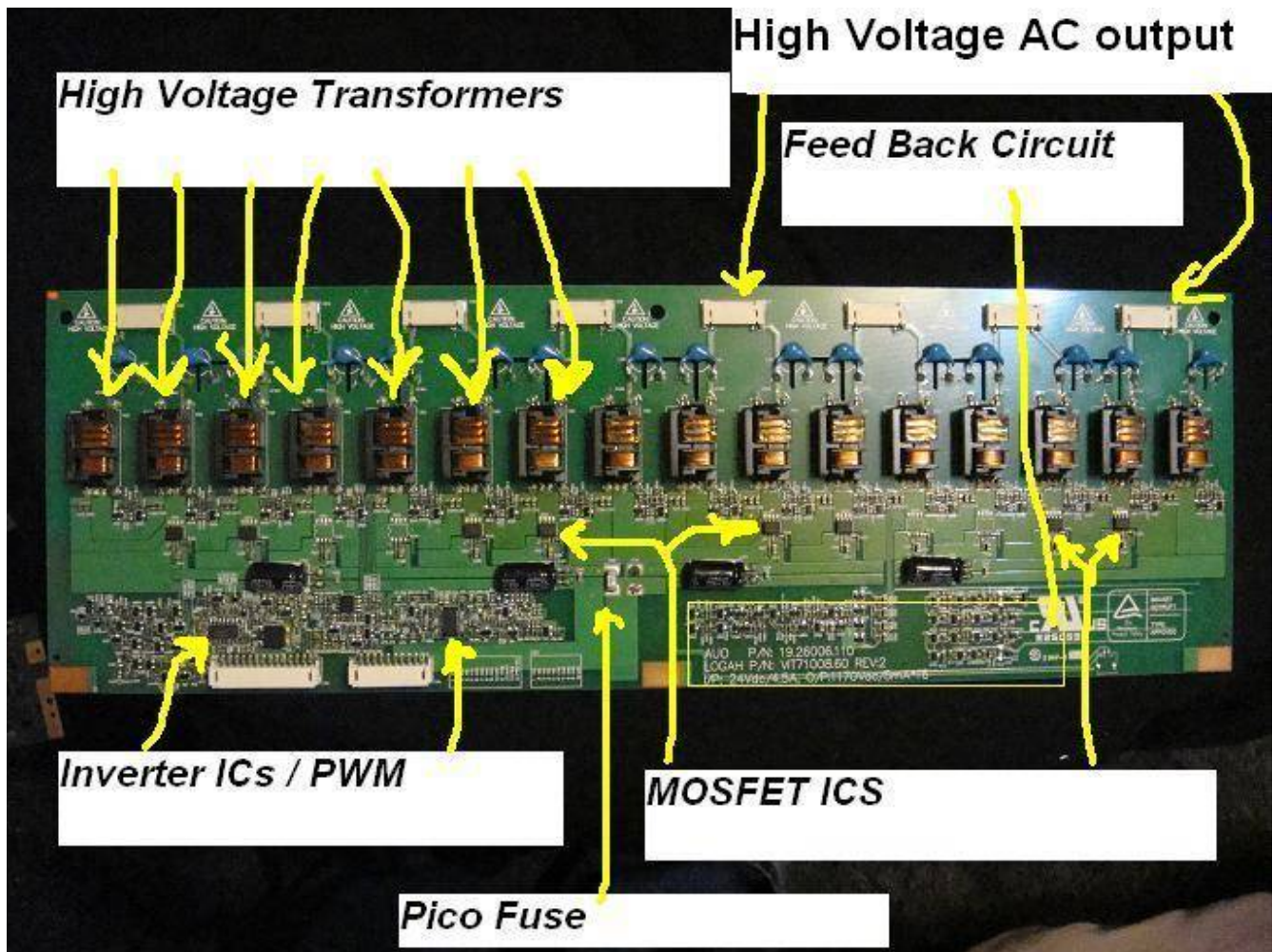

The inverter board is responsible for stepping up the low DC voltage supplied by one of the outputs from the SMPS into a high voltage, roughly 1500V-1800V AC for striking(start up) and 500V-1000V AC to run the CCFL lamps that provide the back lighting for the LCD panel.

For many years designers have used a buck/royer inverter topology to strike and supply power to the CCFLs. This topology is basically a combination of a step down buck regulator, a royer oscillator and a step up transformer.

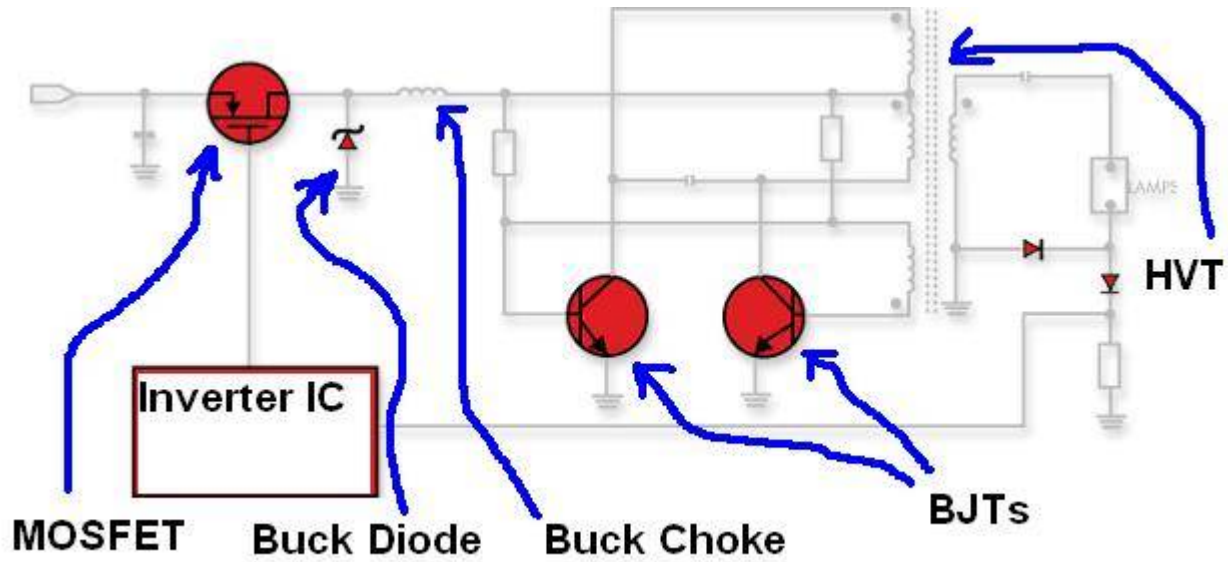

Buck Royer circuit simplified

The buck regulator is made up of a power transistor, buck choke, buck diode, buck coil, power inductor, a PWM or inverter IC and a capacitor.

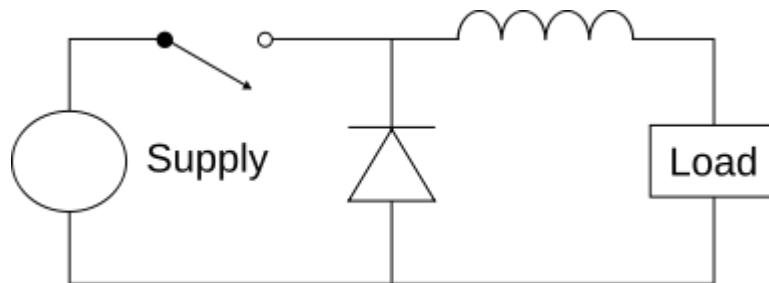

Simplified Buck Converter

The royer oscillator consists of two transistors, capacitor, HVT (High Voltage Transformer) and a capacitor in series with the lamp called the ballast capacitor. The buck royer inverter supplies a high voltage AC to drive the CCFL lamps.

I don't think you will come across to many LCD TVs with the Buck/Royer style inverter circuit but it is still good to understand how different circuits work as you will see similar circuits employed in different parts of the TV and other electronics devices you decide to repair. The majority of inverter circuits you will encounter in LCD TVs will implement PWM type inverters such as the direct drive topology.

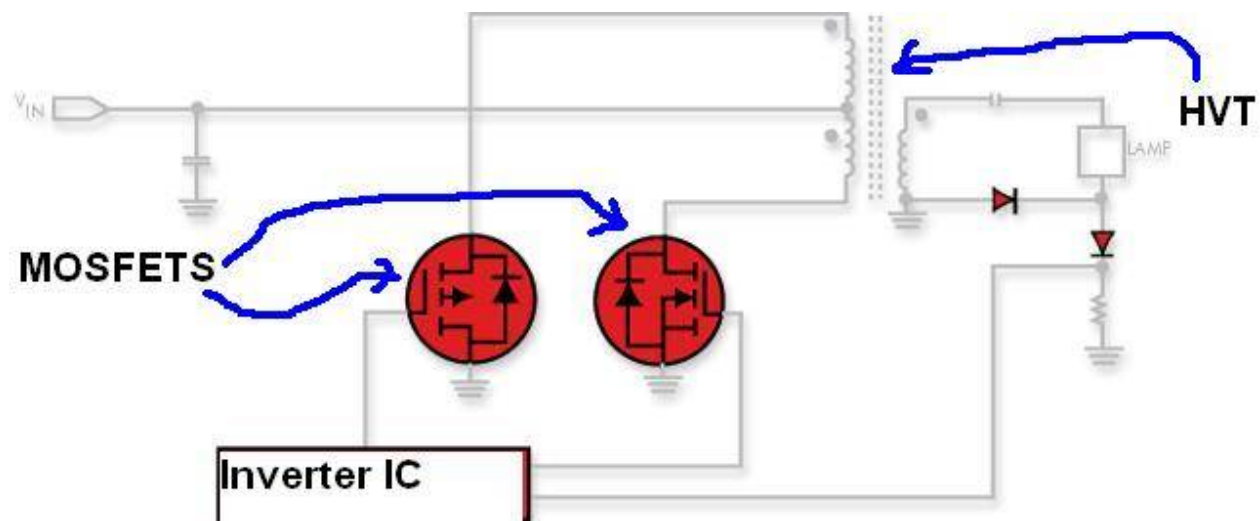

Direct drive topology

The direct drive inverter uses a simple topology that optimizes performance, has a reduced cost and lowers component count by eliminating the buck choke, buck diode, resonant capacitors and transistors found in a Buck/Royer oscillator. The direct drive topology uses a Power IC to drive a pair of MOSFETs connected to a HVT primary winding, switching the MOSFETs on and off at separate times, allowing current to flow through the primary windings center tap and back and forth through the primary winding and one of the MOSFETs to hot ground. The type of direct drive inverter we just discussed may also be referred to as a push pull circuit.

Another common type of inverter you will see is the full bridge inverter.

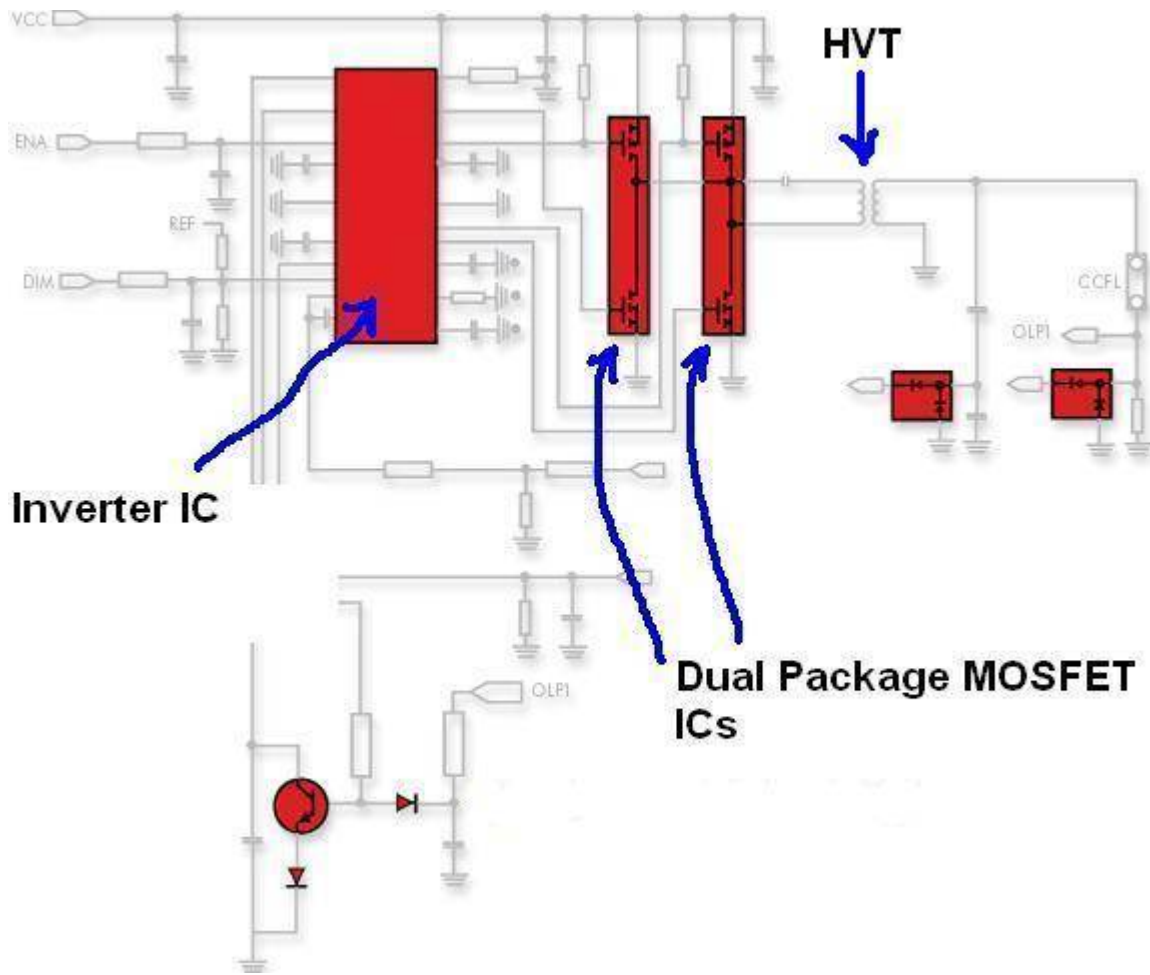

Full bridge topology

The full bridge inverter is like the direct drive inverter I showed you earlier only the center tapped primary is no longer required. The MOSFETs are in a classical H-Bridge topology that is used to reverse the current flow through the primary winding of the high voltage transformer. You will commonly find this type of inverter in today's LCD TVs. Note that some TVs you will encounter will have the PSU and the inverter integrated into one board. You may also encounter some other inverter topologies like the half bridge inverter.

The Main Board

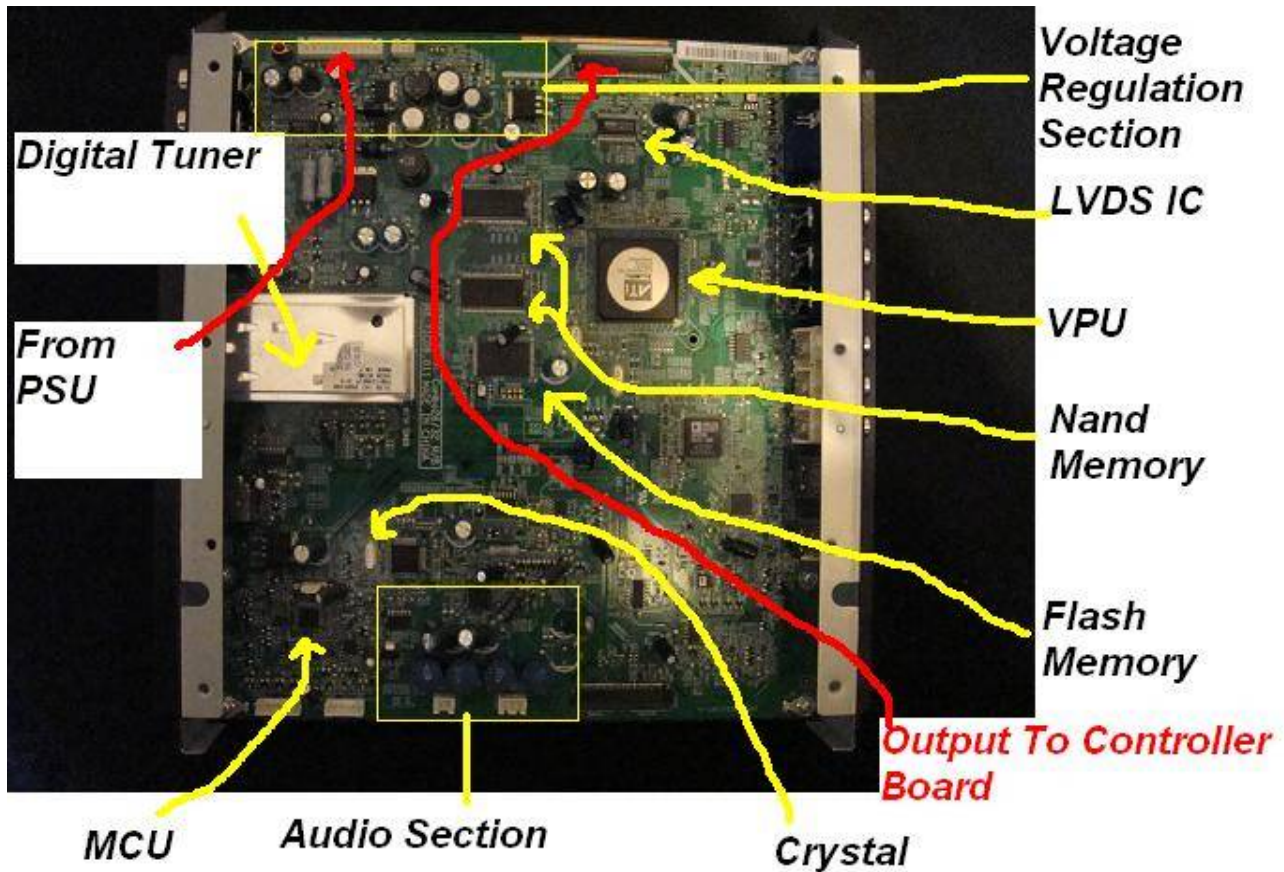

As the Name implies the main board has many functions within the LCD TV. You may also hear this board referred to as the A/D board, logic board, digital board and also the scaler board. The purpose of the main board is to take the input video and audio signals convert the analogue video signal into a digital signal that the controller board can use to drive the TFTs in the panel and control the picture. The audio is taken to the audio processor than an audio amplifier which then drives the speakers. Sometimes all of the video and audio inputs will be found on the main board and sometimes they will be found on a separate board called the jack pack, which connects to the main board via a ribbon cable or FFC (Flat Flexible Cable). This board may also house the audio processor and audio amplifier ICs and corresponding circuits.



Flat Flexible Cable

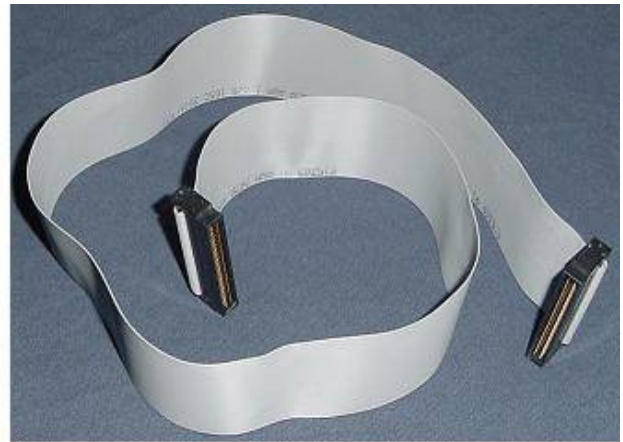

Ribbon Cable



LCD TV jack pack/Input or signal board

Next we will discuss important components found on the main board.

VPU(Video Processing Unit)

The video processing unit is a highly integrated circuit that includes a CPU(Central Processing Unit), HD(High Def.)/SD(Standard Def.) video and audio decoder, NTSC video decoder, OSD(On Screen Display)comb filter a video scaler and de-interlacer. To fully explain the VPU is beyond the scope of this book and I suggest you do further studying if you want o understand the VPU better. The main thing for you to understand is it converts video information into digital signals that can be sent by the LVDS IC to the controller/T-Con board.



VPU

VPU on LCD TV main board

MCU(Micro Controller Unit)

A micro controller is a small computer made up in a single integrated circuit consisting of a fairly simple CPU(Central Processing Unit) along with support functions like crystal oscillator, timers, watchdog timer, serial and analog I/O etc. Program memory like NOR flash or OTP ROM can be included on chip as well as small amounts of RAM. The MCU carries out small dedicated tasks within the LCD TV.

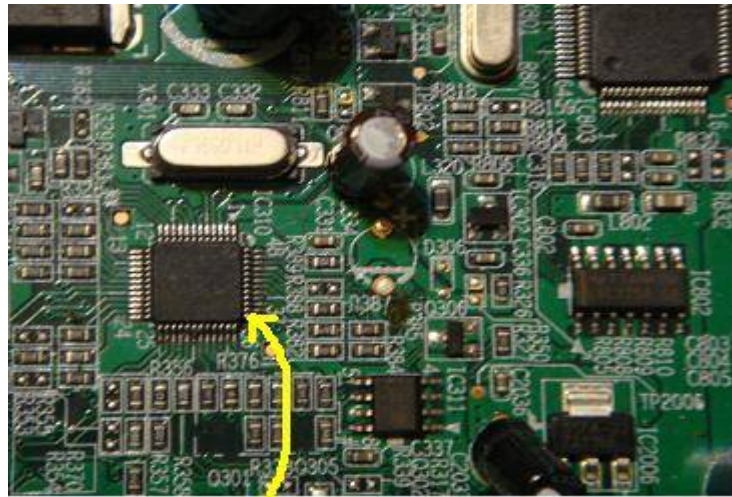

MCU

MCU on LCD TV main board

EEPROM(Electrically Erasable Programmable Read Only Memory)

EEPROMs are a type of non-volatile memory used in electronic devices. Just as the name implies an EEPROM can be erased and programmed with electrical signals. EEPROMs are used to store information such as user adjustable settings and preferences among other things. When you make for instance a brightness adjustment the MCU may store this information in an external EEPROM.

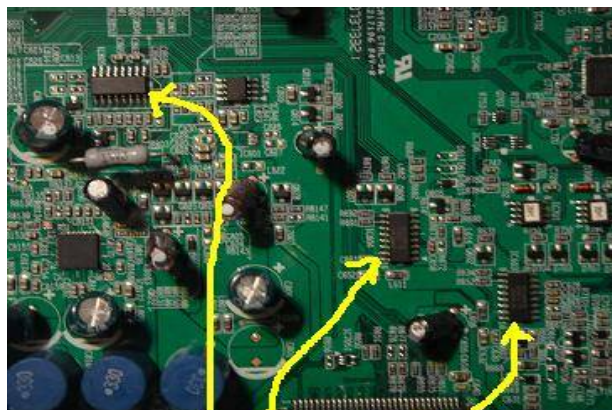

EEPROMS

EEPROMS on LCD TV main board

Voltage Regulator ICs

Voltage regulator ICs provide a constant stable voltage for the ICs and other circuits found on the main board.

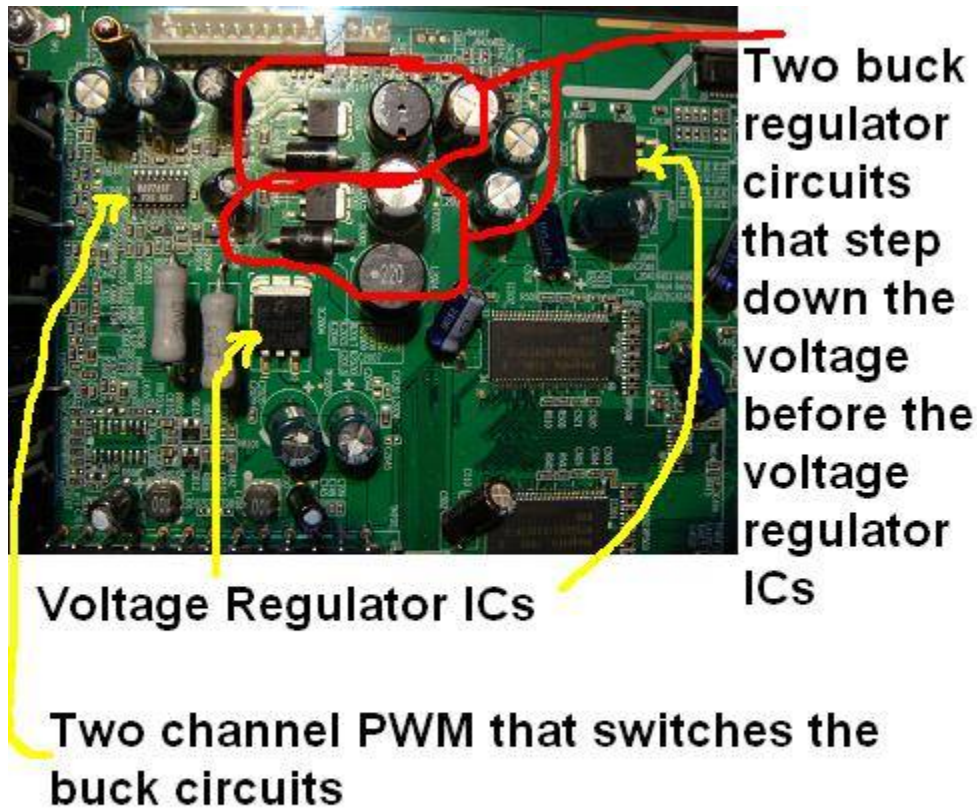

Flash Memory

Flash memory is non-volatile and it is a specific type of EEPROM that is erased and programmed in large blocks. Flash memory costs much less than byte-programmable memory EEPROM and so is dominant wherever a large amount of non-volatile memory is needed. The LCD TV software is usually stored on flash memory and this software can sometimes be upgraded through a USB port or memory card reader on your TV.

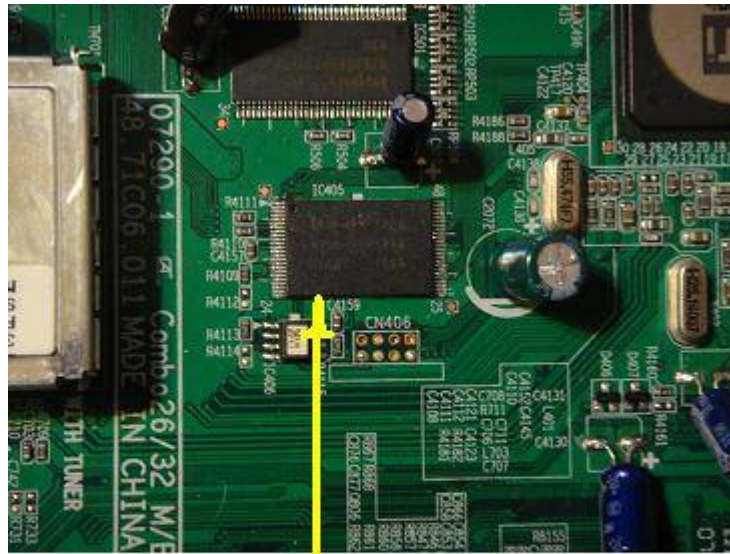

Flash Memory

Audio Processor

The audio processor receives digital and analogue audio signals input to the TV and converts them into a signal that can be used by the audio amplifier to drive the speakers and also to decode and send audio to peripheral devices.

Audio Amplifier

The audio amplifier as the name implies is responsible for receiving the signal from the output of the audio processor which is small in amplitude and using it to drive a signal with larger amplitude but the same modulations through the TV speakers.

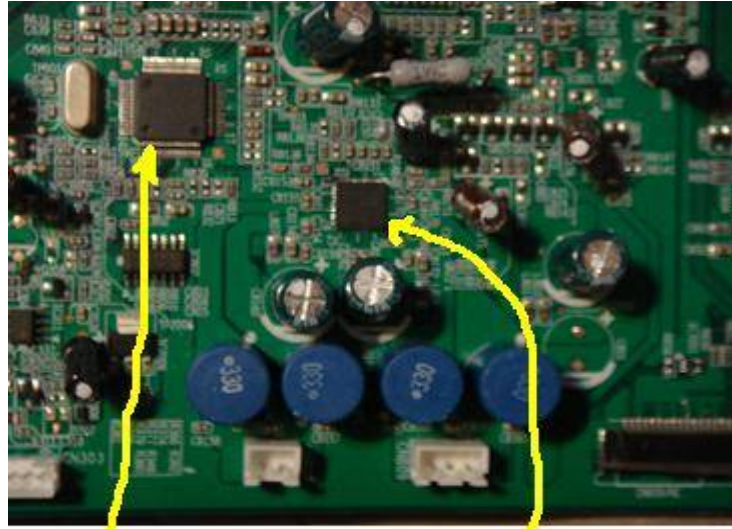

Audio
Processor

Audio
Amplifier

LVDS(Low Voltage Differential Signaling)IC

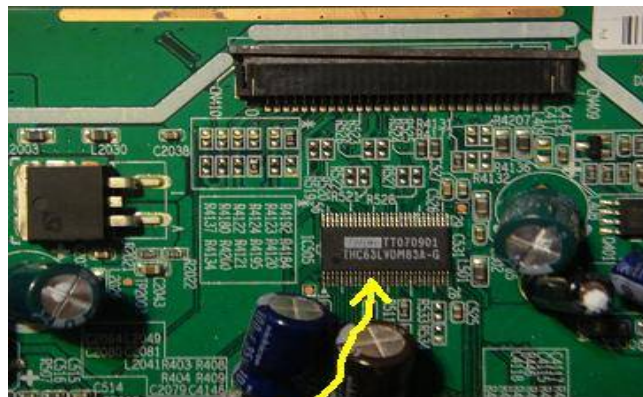

LVDS IC

The LVDS IC uses low voltage differential signaling to send the video signal from the main board to the T-Con/LCD controller board . LVDS is a differential signaling system, meaning that it transmits two different voltages that are compared at the receiving end. LVDS uses this difference in voltage to encode the video signal.

Crystals

The function of the crystal is in combination with other components to create an electrical signal with a very precise frequency. This frequency is used to provide a stable clock signal for an IC. The most common type you will see in the LCD TV is the quartz crystal oscillator.

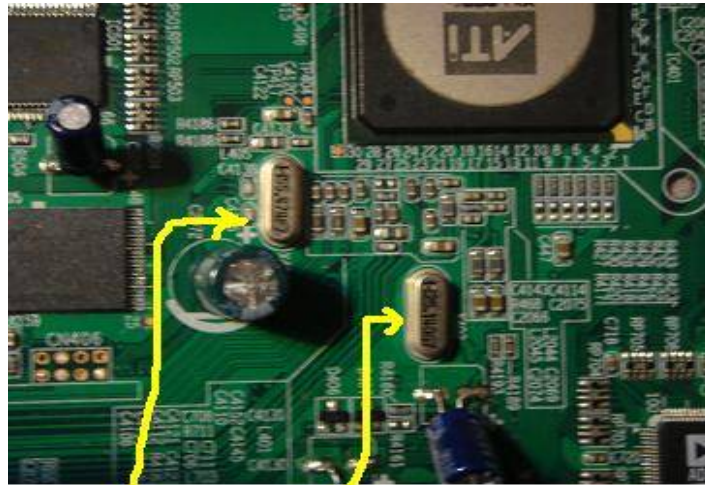

Crystals

Again remember that not all LCD TVs are the same. In this book I am giving you examples of what is commonly seen in LCD TVs on the market today. You will find that some TVs will incorporate different technologies on their main boards. It is up to you to do further studying as needed like reading the service manual and going over the schematics for the TV you are working on if possible, but always be learning about electronics and electronics circuits so can quickly identify them when you see them and troubleshoot them quickly as you know how they operate.

The LCD Controller Board

The LCD Controller or T-Con PCB receives the LVDS signal from the Main Board which it processes into TFT Drive Signals and then through the driver board controls the LCD Panel driver ICs. On the T-con PCB you will find Dynamic Ram IC's which are High Speed Storage Devices used to store data until it is time to be addressed. 12V is usually supplied to the T-con Board through the cable from the main board to the T-con board. This voltage is easily measured at the picofuse on the T-con board.

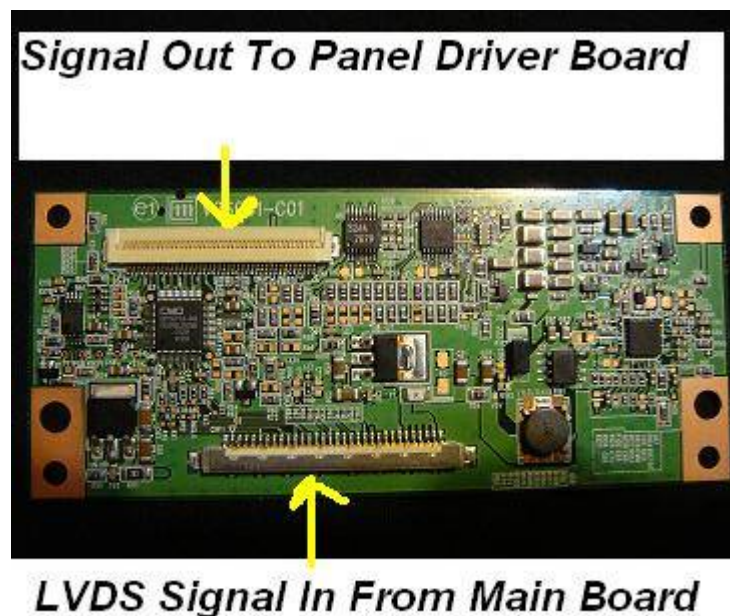

LCD controller board

The LCD Driver Board

The LCD driver board is directly bonded to the LCD panel by flexible printed circuit board(FPCB). The driver board directs the signal from the LCD controller to the driver ICs which are mounted directly to the FPCB that bonds the driver board to the LCD panel and on FPCB down the side of the panel. Sometimes you will see different configurations like the T-Con/LCD controller board and driver board can be integrated into one board.

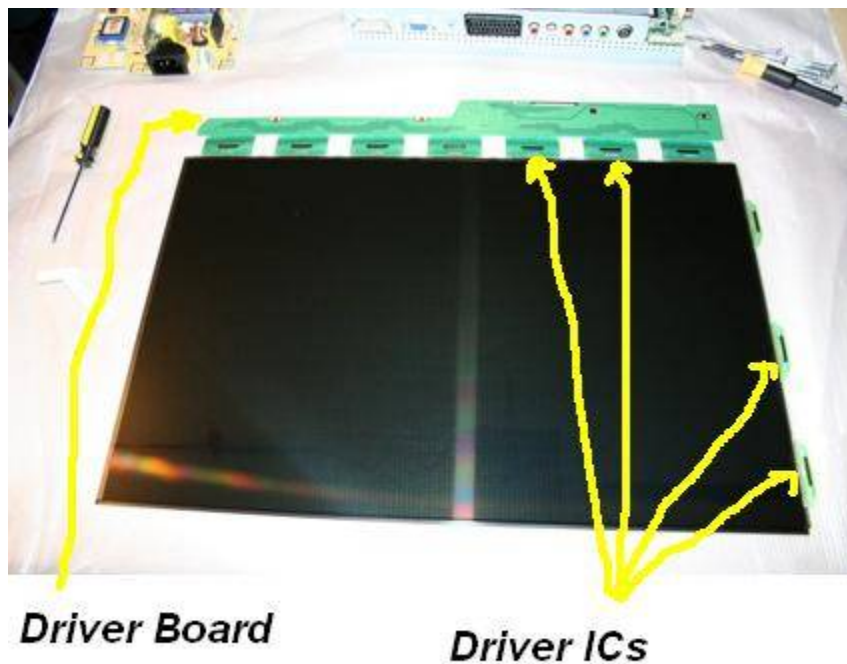

The Standby Circuit

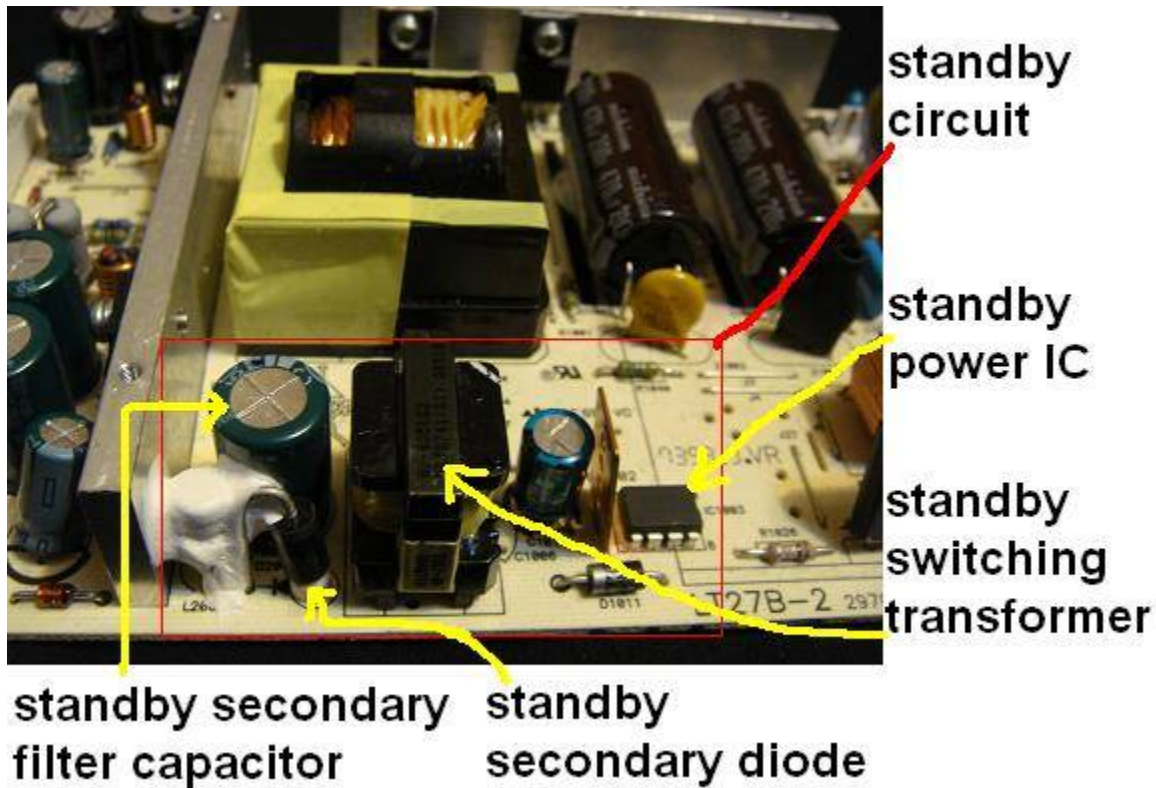

The standby circuit is used to supply power to the MCU and other components in the LCD TV when the TV is off, this is why it is called standby mode. Really the TV is not off completely unless it is unplugged. This is how you are able to turn the TV on when the TV is in standby mode. When you push the power button on the remote control or on the keyboard located on the TV a signal is sent to the MCU that tells the MCU to send a start up signal to the power IC to start driving the power MOSFETs which causes the TV to turn on. The standby circuit is found on the SMPS board and is easily located by it's small switching transformer. The usual standby voltage is 5V DC. The standby power supply is an SMPS usually with the PWM and MOSFET integrated into a single standby power IC, small switching transformer, secondary diode, filter capacitors, feedback circuit etc. It is a fully functional SMPS only really small, an SMPS within an SMPS.

The Liquid Crystal Display In Depth

As we stated before the Liquid Crystal Display contains many layers. A back light, polarizing filters, color filters, TFT layer and liquid crystal. The very back of the panel is a back light which contains multiple CCFL lamps. Some newer TVs use LEDs for back lighting or edge lighting with a light guide, allowing light to evenly illuminate the entire picture even though the light source is around the edge and not directly behind. The light passes through the actual LCD panel that contains all the tiny red, green and blue cells that make up the pixels allowing the picture the display produces to be illuminated and seen.

Panel Types

Passive Matrix-

Passive matrix panels use a simple grid to address a particular pixel in the display. As the number of pixels and the corresponding columns and rows of the grid increase this type of display becomes infeasible. Slow response times and bad contrast are typical with this type of display.

Basic composition of a passive matrix display

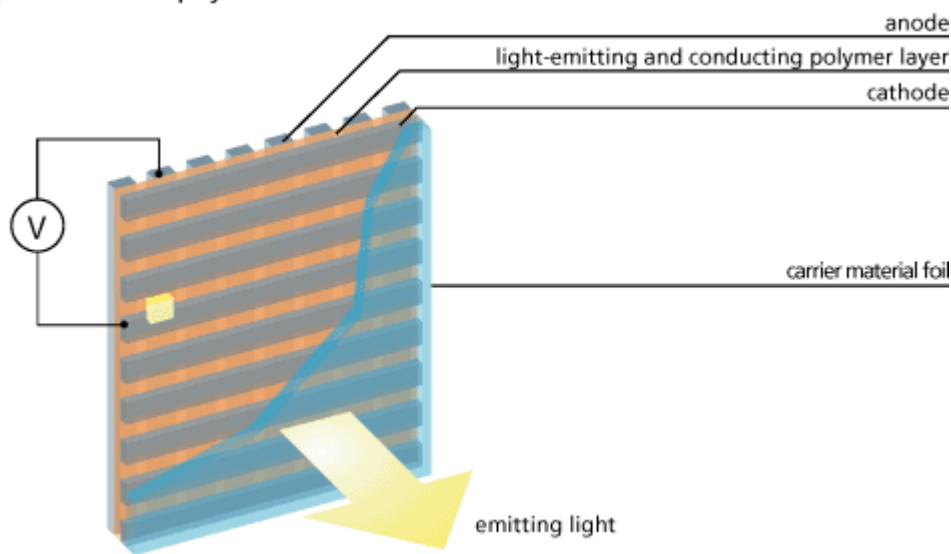

Active Matrix-

Modern LCD TVs use the active matrix structure. The matrix is made up with TFT (Thin Film Transistors). Each cell within a pixel has its own dedicated transistor. This allows each cell to be activated individually.



Active matrix addressed displays are brighter, sharper and generally have better response times not to mention producing better images than passive matrix addressed displays of the same size.

Response Time

Response time is the amount of time it takes for a liquid crystal cell to change from activated or white to inactive or black and then return to white. Basically it refers to the speed of the liquid crystal cells and how fast they can change from one state to another and so how fast the images can be refreshed on the screen. The faster the response time the better. This reduces the effect of trailing or ghosting that can be caused by slow response times. Typical response times are from 4ms-16ms.

Contrast Ratio

Contrast ratio is the ratio of the TV's brightest white it can display in comparison to its darkest black.

Viewing Angle

the viewing angle of the TV is literally the angle at which it is best viewed from. Usually the horizontal and vertical viewing angles will be listed in the user's manual. Ideally a TV would have a viewing angle of 180 degrees both horizontally and vertically, which would mean it could be viewed even if you were standing at the very side or looking at it from the very top or bottom. Modern LCD TVs have a wide viewing angle, usually around 170 degrees horizontally, vertical viewing angle can vary. When a TV has a small viewing angle you will notice the picture fade and the colors distort as you move up and down or side to side relative to the TV.

Resolution

The resolution of an LCD TV is the number of distinct pixels it can display. It is simply the physical number of columns and rows of pixels creating the display. LCD TVs commonly display the following resolutions.

SDTV(Standard Definition TV): 480i

EDTV(Enhanced Definition TV): 480p(720 x 480)

HDTV(High Definition TV): 720p(1280 x 720)

HDTV: 1080i (1920 x 1080)

HDTV: 1080p (1920 x 1080)

The i stands for interlaced scan. This means for each frame you have two "fields" during the first field the display is scanned for part of frame and then skips a piece of that same frame then scans another piece until the end of that field, then the process repeats filling in the parts that were missed in the first field scan. The two fields together make up one frame.

The p stands for progressive scan. This is when the scan starts at the top of the panel and drives every necessary cell all the way down the screen completing an entire frame in one sweep as appose to two.

Tools



Let's discuss some tools that are necessary for repairing LCD TVs and some that will make repairing LCD TVs much easier and reduce your troubleshooting time.



Long Nose Pliers

Long nose pliers come are great for all sorts of things including helping to remove

and place/mount components in places that our fingers can't fit.



Diagonal Cutters

Diagonal cutters really come in handy. Good for cutting of a strip of solder wick and always being used to clip off components leads after soldering them in place.



Nut Driver



Screw Drivers

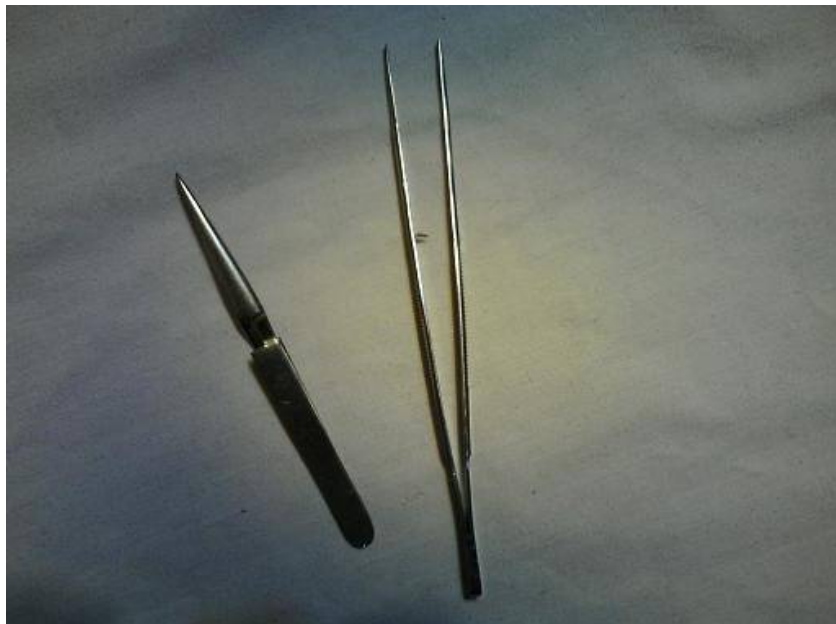

Tweezers

Tweezers come in handy, especially when you are removing or replacing SMD components.



Soldering Kit

You will want to put together a soldering kit that includes such things as solder, solder wick, solder tip tinner/cleaner, heat sink compound, a solder sucker some dental picks and a “solder aid kit”.



Optical Visor With Light

An optical visor is something I just could not do without, I use them to find bad solder connections on PCBs and I basically wear them the whole time I am working, when soldering and to look at part values for instance on SMD components, it would be very difficult to work with out these and it is important that they have a light so you can keep your hands free for things like a soldering iron and solder etc. Without proper lighting and magnification it would not be possible to even see a lot of the connection problems I have found while I was wearing them.

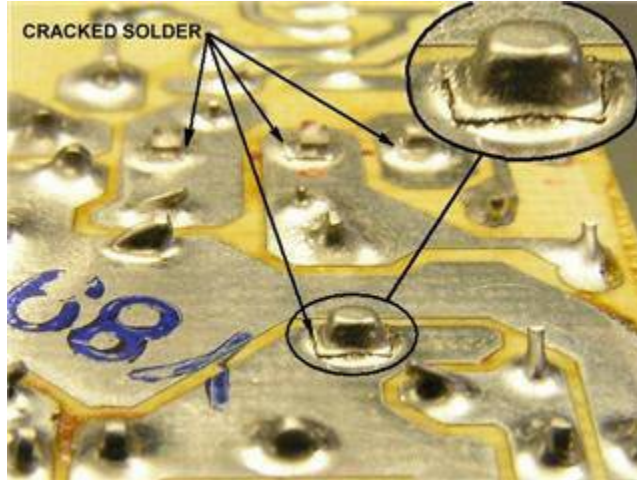

Example of solder cracks that you might not see without a light and magnifier



Variable temperature soldering station with LED display

A good variable temperature soldering station is an essential if you plan on doing component level repairs on LCD TVs. I recommend spending the money to get a nice station with variable temperature like the one in the above photo. It will surely pay for itself in just a few repairs.



Solder Tip Cleaner



SMD rework station

An SMD rework station is not a must for doing LCD TV repair, but if you decide to take on lot's of SMD level repair within the LCD TV this will surely make your life much easier.



Chip Quick SMD removal kit

Chip Quick is one of my favorite products. This is what I choose to use over an SMD rework station for the amount of SMD work I find myself doing. I have even removed and replaced tsop (thin small-outline package) flash ICs with 50 pins with this stuff and other products form their website, it is amazing.



Complete Electronics Tool Kit

All the tools listed are just some of the most important tools needed, but I personally feel the more tools the better and I am known for carrying a large amount with me most of the time. You may want to think about purchasing one of the complete electronics tool kits like in the photo above. You can purchase these kits from various electronics distributors online.

Test Equipment

DMM(Digital Multimeter)-

DMMs in general have less effect on the circuit being tested than an analogue meter and few circuits are effected by having this type of meter connected to them. Most DMMs have a constant input resistance of 10M ohms or more.



Digital Multimeter

The DMM is probably the piece of test equipment you will find yourself using most as it has so many features. Many DMMs include settings for resistance, DC and AC voltage, frequency and duty cycle, DC and AC current, capacitance, continuity, transistor hFE, temperature, diode testing and more. Purchasing a quality DMM is definitely a wise investment.

Analogue Meter-

The analogue meter is also a very useful tool for the electronics technician. The voltages used by the meter for testing are larger than with a DMM and so they can “turn on” certain parts that the low voltages used with most DMMs cannot.



Analogue Meter

Analogue meters are great for testing MOSFETs, BJTs(Bipolar Junction Transistors), opto-isolators, capacitors, LEDs and other components as well. Analogue meters are very reasonably priced and you can find a pretty nice one online for under \$30 USD.

The ESR Meter-

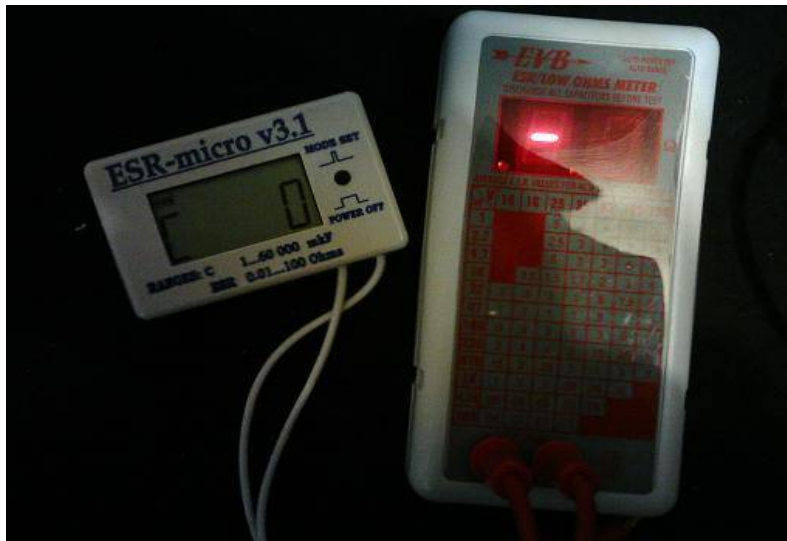

The ESR meter is an important tool for the electronics technician or hobbyist. Electrolytic capacitors that have increases in ESR are often the reason electronic devices fail. Bad electrolytic filter capacitors in the SMPS can cause all sorts of problems in LCD TVs including no or dim display, flickering display, no power nor audio etc. There is also lot's of electrolytic capacitors on the main board which can also cause many problems like loss of OSD, artifacts/glitches in the picture no video etc. when the capacitors fail.

ESR stands for Equivalent Series Resistance and is an effective resistance that is used to describe the resistive aspect of the impedance of certain electrical components. The theoretical treatment of capacitors assumes they are perfect components contributing only capacitance to a circuit, but all physical devices are constructed of material with some resistance to electricity. This means a capacitor has a resistance as well as a capacitance. Capacitors also exhibit reactance which we will not discuss now.

Most electrolytic capacitors have a low ESR to begin with, depending on a specific capacitor and the average ESR can usually be found on the spec. sheet for a certain capacitor if you can find one. Most likely you will refer to the chart of common ESR values that will come with your ESR meter or you can also find them listed on the internet. Normally with a bad electrolytic capacitor the ESR is quite higher than the common range. A capacitor ESR rises over time as they are exposed to and or dissipate heat, because they contain a liquid electrolyte when

they get hot the liquid expands and is vented out of the capacitor and also the electrolyte can break down and go through chemical changes over time and exposure to heat also causing the ESR to increase.

The ESR meter is so valuable because it allows you to quickly check the many electrolytic capacitors found in LCD TVs and other electronic devices and very often you can test them in circuit all though if you ever doubt the reading it never hurts to test the capacitors out of circuit and this is a good practice with all components or at least to unsolder and lift one of the components leads from the circuit.

The Ring Tester-



The ring tester is an inexpensive and effective way to test any high Q inductive component. In LCD TV repair the ring tester is very useful for testing switching transformers in the SMPS and HV transformers on the inverter board.

The components in many circuit like the SMPS and inverter board contain low loss(high Q) resonant circuits. The ring test got its name from the fact that when a very fast pulse of current is sent through a high Q circuit the tuned nature of the circuit will produce a decaying AC voltage of several cycles or more. The more rings the higher the Q. Little or no rings indicates low Q and a problem.

The Oscilloscope-

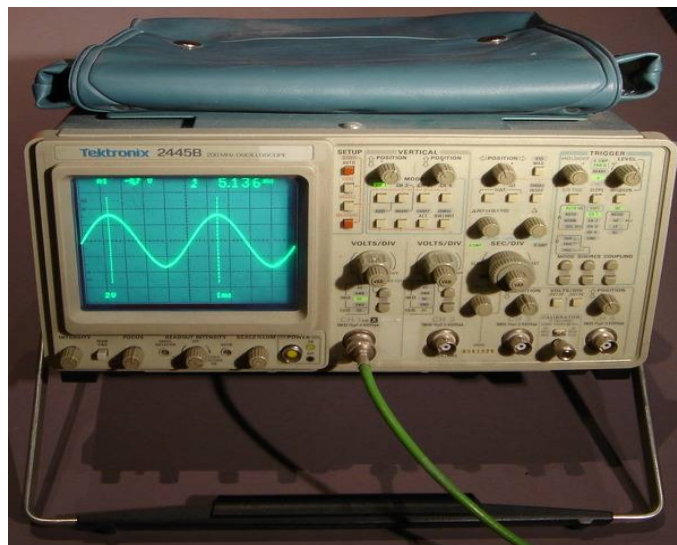

The oscilloscope or “scope” is a piece of electronic test equipment that is used to view signal voltages and frequencies, usually as a two dimensional graph. It is driven by an input signal that has the effect of producing a recognizable pattern on the screen that describes certain aspects of the signal. Oscilloscopes are very useful tools and can help to quickly locate problems within electronics devices. I assume that many of the readers do not own an oscilloscope or have access to one. Fortunately this book will be repairing LCD TVs with mostly a DMM , analogue meter, ESR meter, ring tester and other tools. I repair lots of TVs and have for years just with mostly those meters I just mentioned, although sometimes I will need a scope for those difficult TVs and in that case, except for a few obvious critical waveforms, like the PWM output from the power and inverter ICs and checking for ripple on the secondary outputs in the SMPS a schematic would be needed to know where and what waveforms to look for in the particular model of LCD TV you are testing.

To learn more about the oscilloscope and how to use one click on the link below.
[The analogue oscilloscope](#)

Digital Capacitance Meter-



A digital capacitance meter with a large range is a good tool for testing capacitors capacitance value.

Leak Seeker-



This is a great tool for hunting down difficult to find shorted components especially circuits with lot's of SMD components. Simply touch LeakSeeker's gold-plated probe on any solder pad along the suspicious trace and LeakSeeker automatically calibrates itself to the resistance of the defect, within a 24 milli-ohm "window". Because the test voltage is a current-limited eight volts, it will power through good diodes to activate shorted components beyond. Touch a pad in one direction or the other and LeakSeeker beeps higher or lower and lights the LED distance scale to indicate that you're getting closer or further from the defect. The 24 milli-ohm window allows about 2 to 3 inches of PCB trace to be checked, then automatically re-calibrates itself to a new window as you get closer to the short. Because LeakSeeker has a range of zero to 150 ohms, it can locate not just shorted, but leaky parts as well. And unlike your DVM, LeakSeeker's unique "floating reference" circuitry doesn't give up resolution at these higher leakage values. Once you're in the general area of the defect, switch from the AUTO to the LOCK position, High Definition mode. This locks the "window" and increases resolution to 0.1 milli-ohm, so you can pinpoint the location of the defect within a quarter of an inch, even on multilayer boards with a power plane instead of individual traces. The currently available LeakSeeker 82B HD has indicators for "standard resolution" AUTO and "high definition" LOCK. The solder pad where the beep is highest is the location of the defect.

Smart Tweezers-



Smart Tweezers is an LCR(Inductance,Capacitance,Resistance) meter in a set of tweezers. Smart Tweezers features a unique patented mechanical and electronic design that integrates a highly accurate digital multimeter with a built-in high precision SMD probes and a display. This light weight device can be easily held by one hand. It is designed for component evaluation on a PCB or a production line, component testing and sorting of SMD components. Smart Tweezers dramatically reduces time necessary to troubleshoot or debug a complex PCB significantly simplifying process of locating a faulty component.

Some Precautions-

Be careful with your test equipment, don't store meters in extreme conditions(e.g. Extreme hot or cold storage). Don't slam or seriously vibrate the meter, especially analogue meters which have delicate parts inside.

Read the manuals that come with your different meters.

Avoid making measurements that exceed the makers recommendation in any particular setting.

Avoid making voltage or current measurements with the meter switched to the resistance setting.

Schematic Diagrams

Schematic diagrams can really make troubleshooting LCD TVs much easier and can often be found online in service manuals available for download. Many times though, the service manuals will not have that much info and have only partial or no schematics at all. This is why it is so important to further your electronics knowledge and to be constantly studying. The more you know about electronics and common circuits, the easier it will be for you to recognize the circuits in the TV you are working on and to quickly see how they work and have a good idea of to start troubleshooting the TV regardless of whether or not you have a schematic diagram. If you have a strong understanding of electronics you will be able to analyze, troubleshoot and repair any circuit. It still never hurts to see what information you can find as the internet has made so much available to the technician and hobbyist repairer that was not available to us in past so easily.

Block Diagrams-

Here is a typical LCD TV block Diagram to help give you an idea of how they work from a to z.

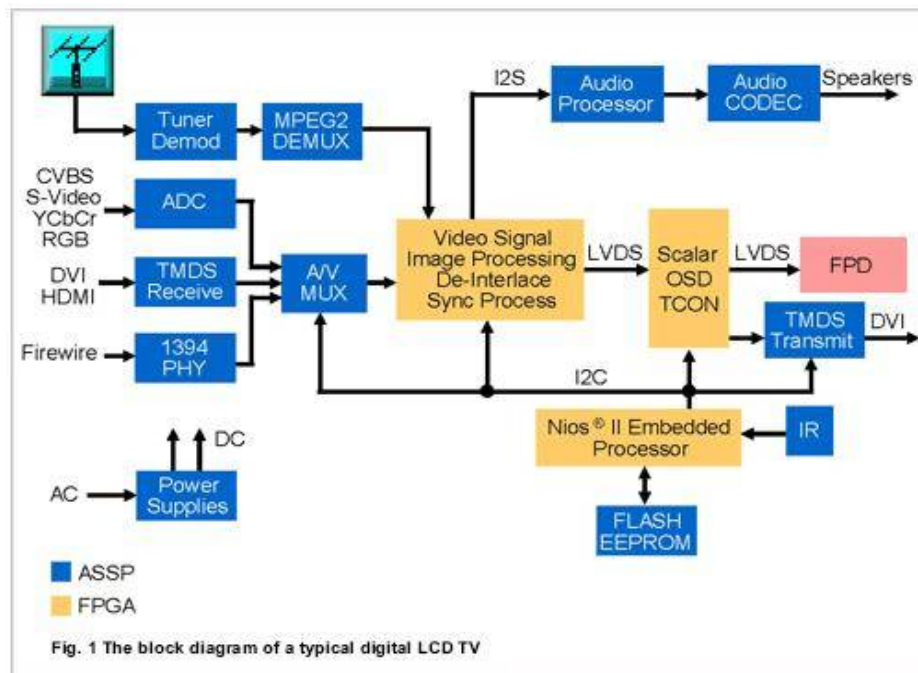

Understanding and Testing Resistors

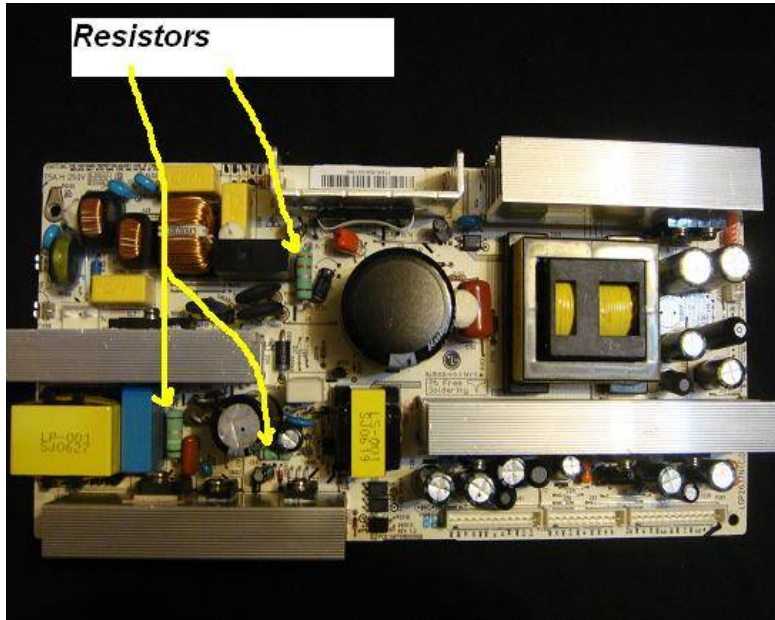

Resistors In An LCD TV Power Supply

A resistor opposes the flow of electrical current. Resistance is measured in ohms. The main characteristics of a resistor are its resistance value in ohms and its power rating in watts. Never replace a resistor with a lower power rating than the one removed from the circuit, it is OK to use one with a larger rating but never lower. Resistor resistance values add normally when connected in series, but add in reciprocal when connected in parallel.

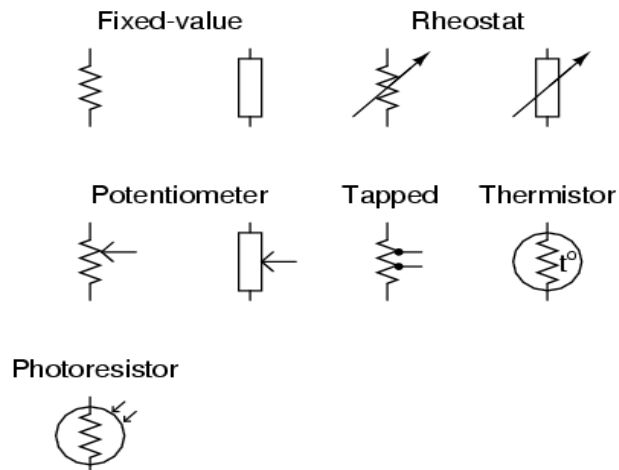

Resistor Schematic Symbols

Reading Resistors-

Resistors are marked with colored bands to indicate the resistance value. Reading from left to right, the first band is the first digit of the resistance value the second band is the second digit of the resistance value. The third band is the multiplier and determines how many zeros follow the first two digits, the fourth band is another important value and that is the tolerance.

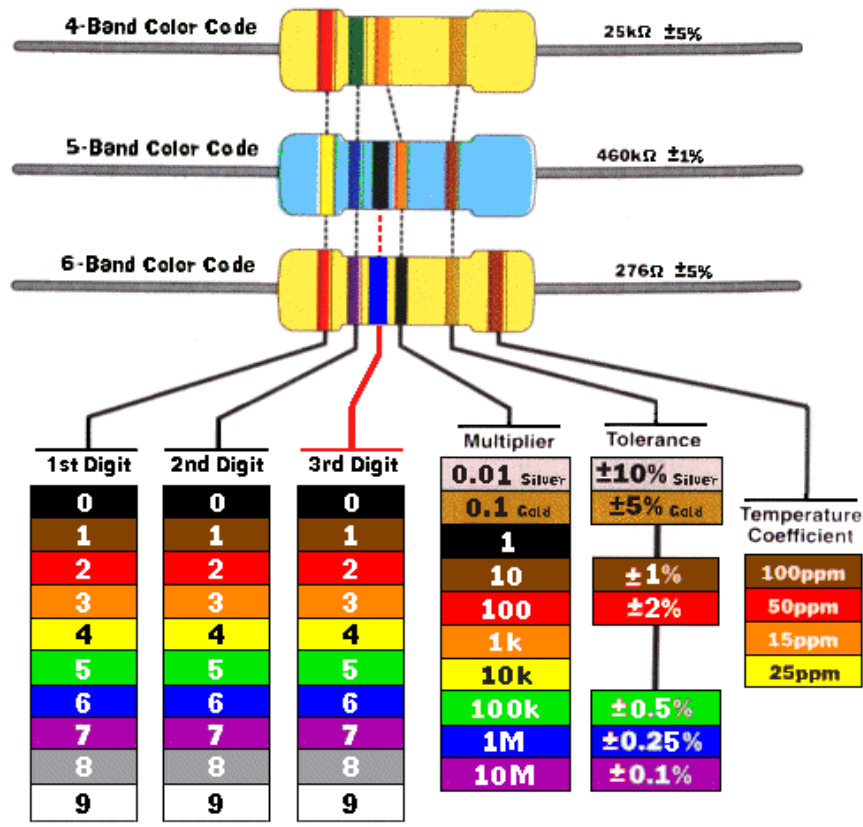

The tolerance is the percent plus or minus that the value of resistance can vary from the value calculated from the color bands. Example, a resistor with bands from left to right of red, brown, yellow and gold would be 210,000 ohms or 210k ohms with a tolerance of 5%. Sometimes you will see resistors with five bands, in this case the first three bands are digits, the fourth band is the multiplier and the fifth band is the tolerance band. Some resistors like SMD ones for instance will use numbers instead of bands but the idea is the same. For an SMD resistor with 3 numbers the first number is the first digit of the resistance value the second number is the second digit and the third number is the multiplier. So an SMD resistor marked 103, would have a value of 10k ohm. An R may be seen in the value for instance 4R7, the R represents a decimal and in this case the value would be 4.7 ohms.

Colour	Digit	Multiplier	Tolerance
Black	0	1	
Brown	1	10	1%
Red	2	100	2%
Orange	3	1.000	
Yellow	4	10.000	
Green	5	100.000	0,5%
Blue	6	1.000.000	0,25%
Violet	7	10.000.000	0,1%
Grey	8		0,05%
White	9		
Gold		0,10	5%
Silver		0,01	10%

Testing Resistors-

Testing resistors can be done with your DMM or analogue meter. Determine the value the resistor is supposed to be by using the color bands or numeric code. If the resistor is burnt or discolored so that you can not read the bands you will need the schematic diagram for the TV you are working on or you will have to use the techniques described in the book, "[Find Burnt Resistor Value](#)" to determine the resistors value through a systematic process.

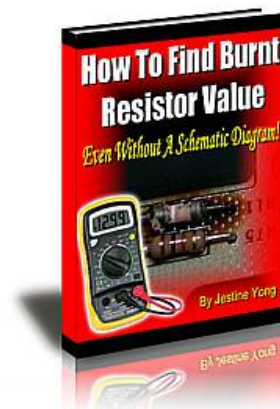

Once you know the value of the resistor you want to test is supposed to be you can simply set your DMM or analogue meter to the proper resistance range and measure the actual value of the resistor. You should get a resistance measurement within the tolerance of the given resistor, most bad resistors will have increased in value or gone open reading O.L./ infinite resistance. Charred and burnt resistors are obviously bad and need replacement. Always remove resistors from circuit before testing, as surrounding components may cause erroneous readings. Wattage is not always listed on resistors and is determined by the physical size.

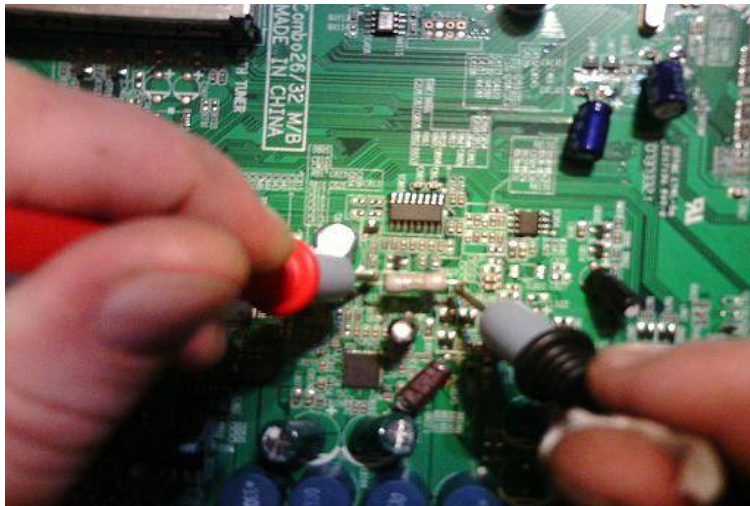

Testing Resistor On LCD Main Board



Meter Reading 218.6 ohms the resistor stated 220 ohms on the side and at 5% tolerance so this as a good resistor

Understanding and Testing Capacitors

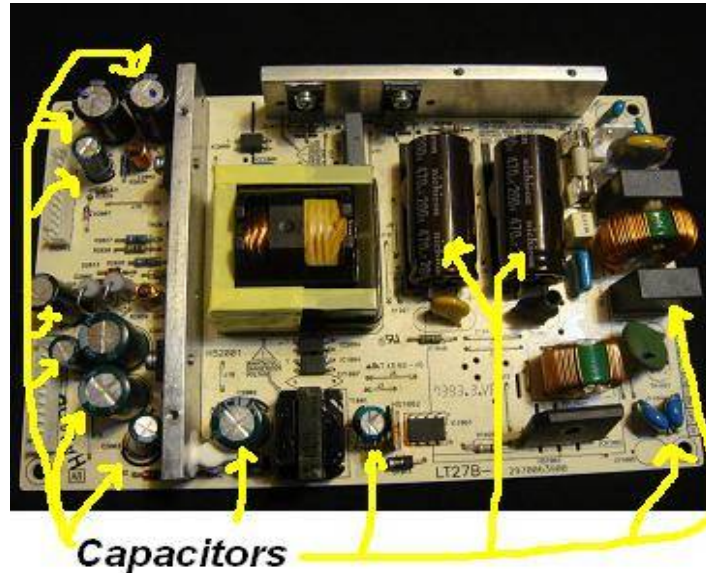

Capacitors In LCD Power Supply

A capacitor is a passive electronic component that consists of two conductors separated by a dielectric(insulator). When a potential difference(voltage) exists across the conductors an electric field is present within the dielectric. The effect is greatest between wide, flat, parallel conductors that are very slightly separated by dielectric.

Non-polarized

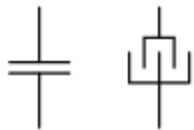

Polarized (top positive)

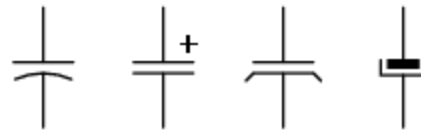

Variable

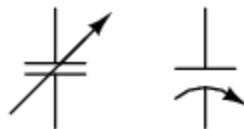

Capacitor Schematic Symbols

Capacitors are widely used in electronic circuits for coupling(blocking the flow of DC while allowing AC to pass), decoupling(also called bypassing, passes DC while blocking or bypassing AC), filtering interference, Smoothing the output from bridge rectifiers, removing ripple on the output of SMPS power supplies and many other purposes. Capacitor capacitance values add normally when connected in parallel, but add in reciprocal when connected in series

Testing Capacitors-

Method one, use your analogue meter set to the x1 ohm range and connect the test leads to the capacitor. The meters needle should kick up and then return to infinity if it does not flick or respond reverse the test leads, if it still does not flick try again with your analogue meter set to x10 ohm, x100 ohm, x1k ohm and then x10k ohm range until you get a response if the meter needle does not flick when the test leads are applied to the capacitor in any setting than the capacitor is considered open. If the needle flicks up and stays at zero ohms the capacitor is considered shorted, also if it stays to any other value other than infinity after flicking it is leaky. This method of testing is fairly old and not the best method. Just because a capacitor can charge or discharge does not mean it is a good capacitor. You can also use your DMM set to the resistance setting to do this test, it should show some reading and then go to O.L.(Over Limit), and if you reverse the test leads it should do the same again.

Method Two-

The second method for testing capacitors is to use a capacitance meter or the capacitance setting on your DMM, if it has one. By placing the test leads of the meter to the leads of the capacitor the meter will display the measured value.

The value of measured capacitance should be what is marked on the capacitor(plus or minus the tolerance value). Please note electrolytic capacitors will have the value for capacitance for capacitance marked on the side in microfarads(uF) along with the working voltage. Most non-electrolytic capacitors will have their value in a numerical code marked on the side.

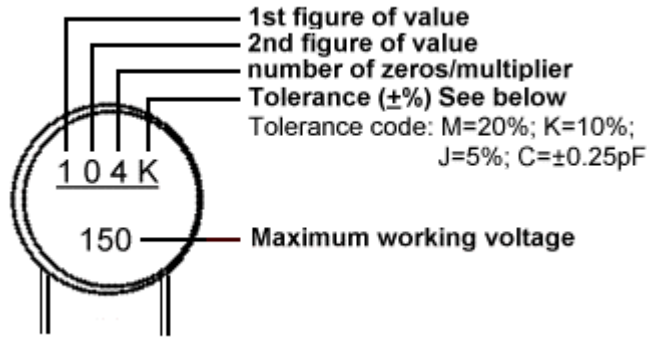

Just like resistors, the first two numbers are the first two digits of the value and the third is the multiplier. The value will be in pico-farads. These three numbers are followed by a letter which denotes the tolerance value. Most electrolytic capacitors in LCD TVs have a tolerance of 20%. Both methods one and two are great for testing non-electrolytic capacitors.

Method Three-

This method involves the use of an ESR meter.



ESR Meter

Electrolytic capacitors are the most common capacitors to fail in electronic devices and one of the most common components you will find failed in LCD TVs in general.

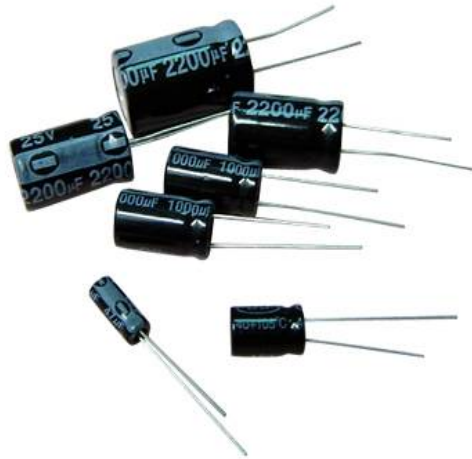

Electrolytic capacitors may test fine with methods one and two but can have a raised ESR which is causing a failure that would be missed by the first two testing methods. In this case you need the ESR meter to find the bad capacitors. To use the ESR meter simply place the test leads to the leads of an electrolytic capacitor and compare the reading(in ohms) to the one on a chart of typical ESR values for electrolytic capacitors that should come with your ESR meter. Most ESR meters will have an ESR value chart right on the meter itself.

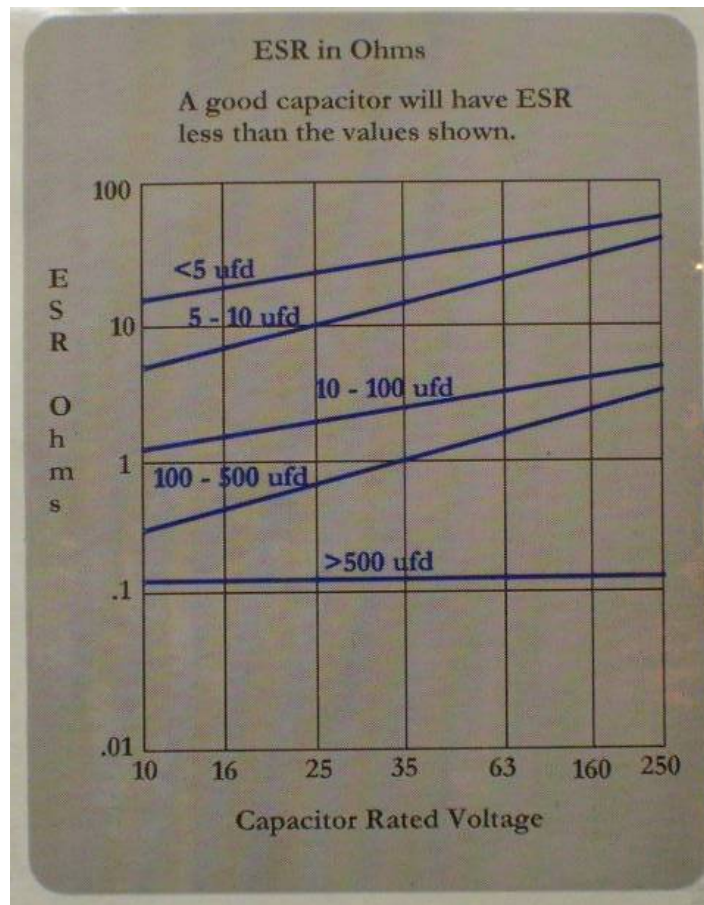

You can usually check electrolytic capacitors in circuit, but I still recommend pulling them out of circuit or at least de-soldering and lifting one lead of the capacitor before testing.

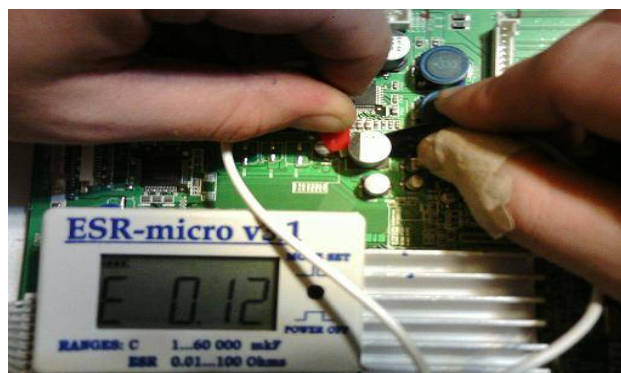

Using ESR meter to test SMD electrolytic capacitors on the main board



Checking ESR Of Secondary Filter Capacitor On Power Supply Board

To sum things up the first two methods are great for testing non-electrolytic capacitors like ceramic disc capacitors, etc., or the first method for testing electrolytic capacitors to see if they are open, leaky or shorted. Also it doesn't hurt to make sure the capacitance of electrolytic capacitors is within tolerance. The third method, using the ESR meter is the best way to test electrolytic capacitors and these are the most common capacitors to fail in electronic circuits, caused by a raised ESR.

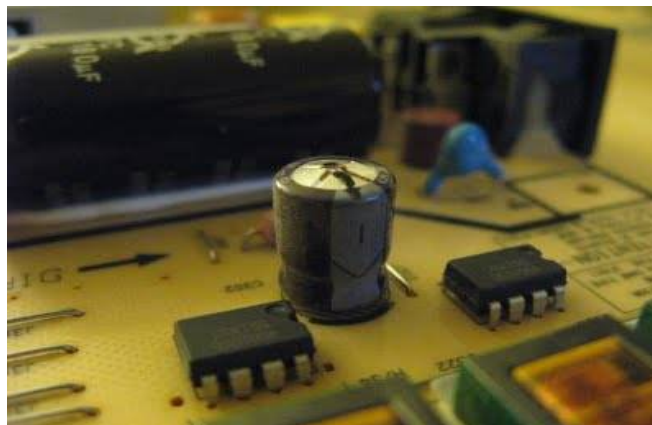

You can tell this electrolytic capacitor is bad just by looking at it, always replace any puffy or vented electrolytic capacitors, no need to even test them except for curiosity.

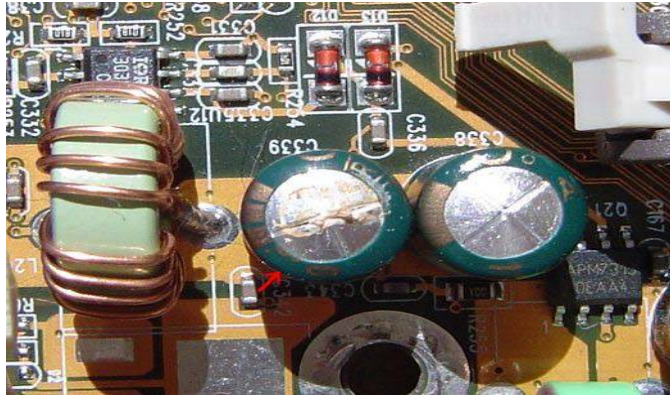

More obviously bad electrolytic capacitors

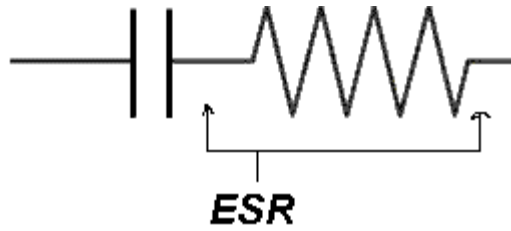

Symbol For ESR

Testing Ceramic Capacitors-



Ceramic Capacitors

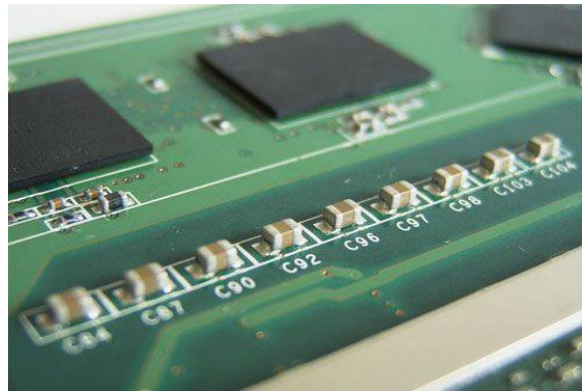

SMD Ceramic Chip Capacitors

Use method one and two described earlier to test these types of capacitors.

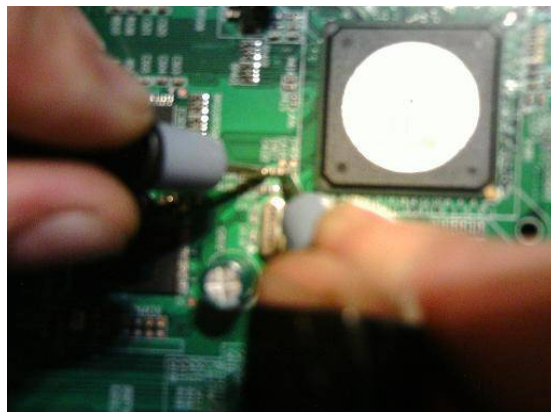

Testing Ceramic Chip Capacitor On Main Board With Capacitance Setting Of DMM



Meter Reading in nF(nanofarads) 0.052 nanofarads or 52 picofarads

To test the high voltage resin coated ceramic capacitors like found on the secondary side of some inverters, you will have to use an insulation tester as the low voltage output from your DMM or analogue meter is not enough to test this type of capacitor. Also these capacitors will also many times have physical damage that you can see like a crack in the resin coating or discoloration or burn.

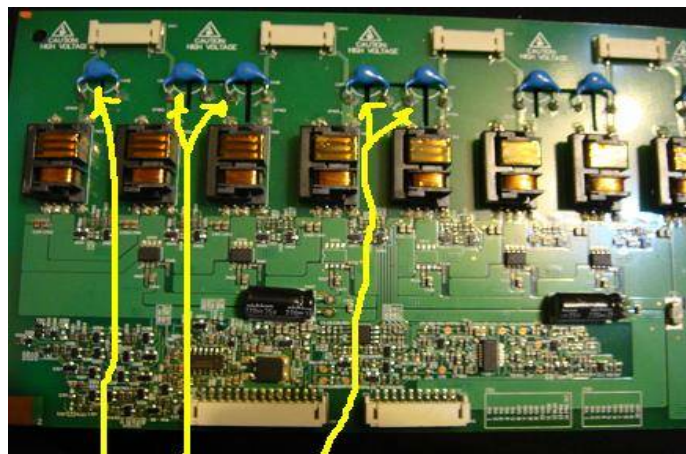

Resin Coated Ceramic Capacitors

5pF 3KV Ceramic Capacitors on Secondary Side Of An LCD TV Inverter



An Insulation Tester

Understanding and Testing Inductors



Inductors In Secondary Side Of PSU

An inductor also called a reactor, coil or choke is a component that exhibits reactance resisting changes in current flow and can store energy in a magnetic field when an electric current pulses through it. Since inductors resist changes in current flow, they attenuate or “choke” high frequency AC signals making them very useful in filters and in tuned circuits.

Fixed-value



Iron core



Variable



Variac

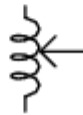

Tapped



Schematic Symbols For Inductors

Testing Inductors-

Testing inductors is fairly simple. Basically an inductor is a wire coil wrapped around a core(some have no core called an air core) often made of ferrite.

Use your analogue meter set at x1 ohm or your DMM set to resistance setting and place test leads onto the leads of the inductor. You should get some reading, usually very very low ohms your DMM may even show 0 ohms. If you get an infinite or O.L. Reading the inductor is considered open and should be replaced.



Testing Inductor In LCD TV Power Supply

If the coil is not open you can also use the inductance setting of your DMM or an inductance meter if you have one or the other and check that the inductance is within tolerance of the value marked on the inductor.

Values are in micro Henries (μH)

First two digits are the value

Third digit is the multiplier

If there is an R, its acts as a decimal point, and there is no multiplier

Examples:

101 = $10 \times 101 \mu H = 100 \mu H$

4R7 = $4.7 \mu H$

Suffix

Sometimes the precision of the inductor will be marked, using a final letter F, G, J, K, or M

F = $\pm 1\%$

G = $\pm 2\%$

J = $\pm 5\%$

K = $\pm 10\%$

M = $\pm 20\%$

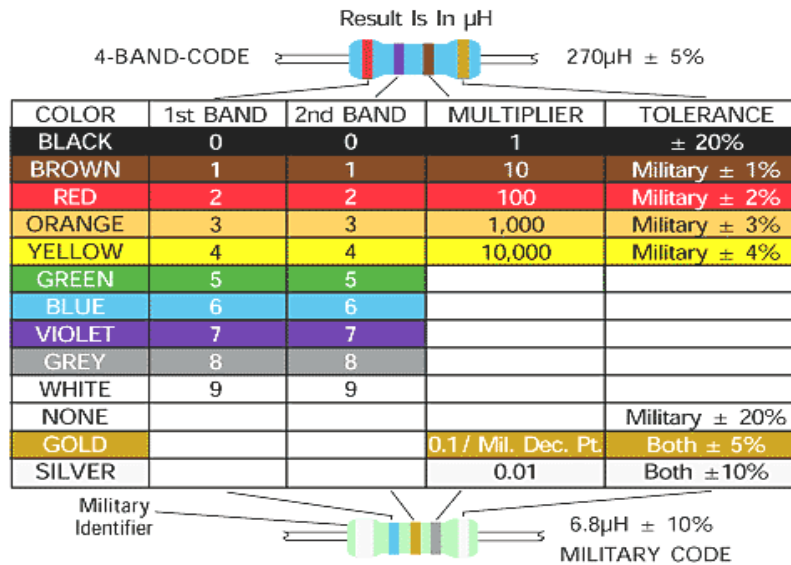

Inductor Color Code

For high Q low loss coils like the primary winding of the SMPS switching transformer you should use a ring tester to check for shorts between windings.

Place the test leads of the ring tester onto the leads of the inductor and check the amount of LEDs that light up to indicate the rings for the coil you are testing, the more LEDs the better. Most High Q coils will light up at least one green LED.

You should see what kind of reading you get from various known good inductors, so you know what kinds of readings you should be looking for when testing inductors in LCD TVs.

Understanding and Testing Transistors

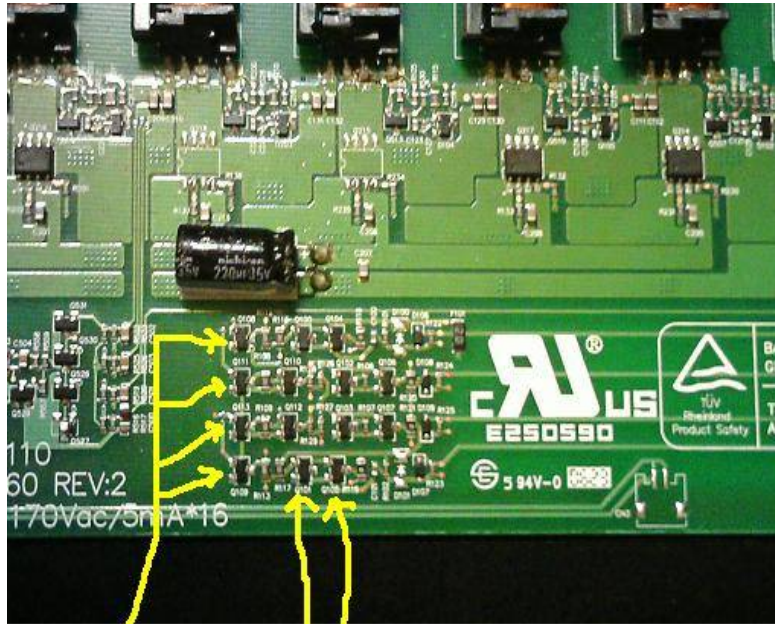

SMD Transistors On Inverter Board

A transistor is a semiconductor device commonly used to amplify or switch electronic signals. A transistor is made of doped semiconductor material junctions, with at least three terminals for connection to an external circuit. A voltage or current applied to one pair of the transistor's terminals changes the current flowing through another pair of terminals.

BJT-

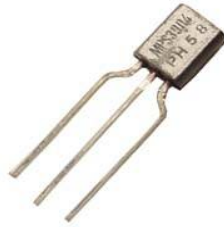

Bipolar Junction Transistors(BJTs) are made from three sections of semiconductor material, alternating p type and n type resulting in two pn junctions, one pn junction existing between the emitter and the base the other existing between the collector and the base. BJTs are classified as npn or pnp depending on the arrangement of there n and p type material.

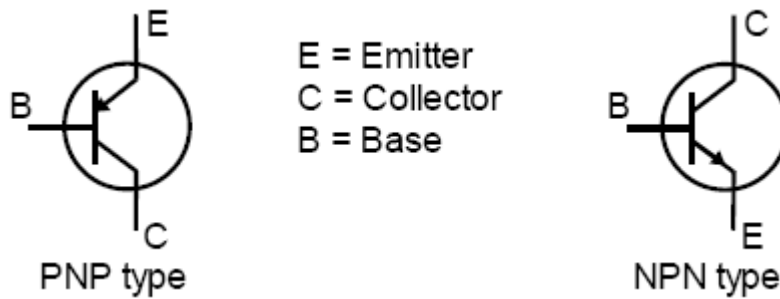

Schematic Symbol

Testing BJTs-

First determine whether you will be testing an npn or pnp transistor and which pins are the base, emitter and collector by looking the transistors part number up online or looking in the LCD TV schematic diagram if you can not find this information, use the method found in this book “[Testing Electronic Components](#)” to determine the information stated above. Once you have determined the type

(npn or pnp) of BJT you will be testing and which leads are the base, emitter and collector you are ready to test. Set your DMM to the diode test setting. For npn type BJT place the black test lead on the base pin and the red test lead on the emitter and then the collector pin, both readings should be O.L.(Over Limit). Next place the red test lead on the base and the black test lead on the collector and then the emitter. You should get about a 0.4-0.7 voltage drop for both readings. Placing the black test lead on the collector and the red test lead on the emitter should give you an O.L, reading and if you reverse the test leads so that the black test lead is on the emitter and the red test lead is on the collector, you should again get an O.L. Reading. Getting a low reading in both directions between base and emitter indicates a shorted junction, also if you get a low reading in both directions between base and collector this also is a shorted junction. A transistor can have one or both junctions shorted when they fail. An O.L. Reading in both directions between base and emitter indicates an open junction as does an O.L. Reading in both directions on base and collector.

Now for pnp you will perform the same test only it will be done with the polarity of the test leads reversed for each step.

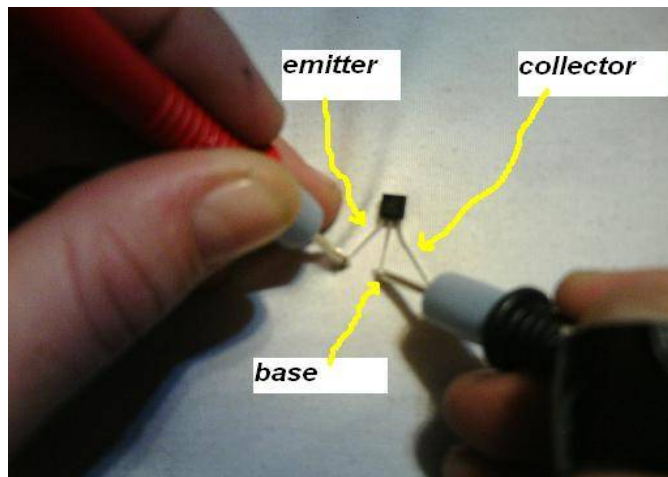

Step 1 Testing an NPN BJT With DMM

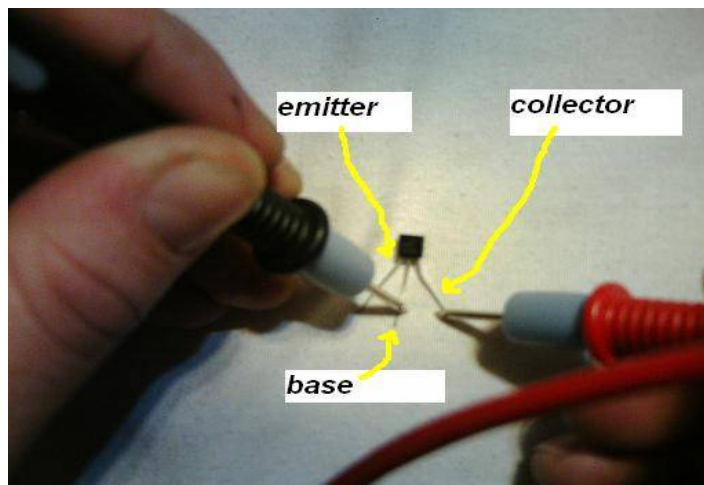

Step 2 Testing NPN BJT With DMM (Simply Repeat 1 & 2 With Test Leads In Reverse Polarity For Steps 3 And 4)

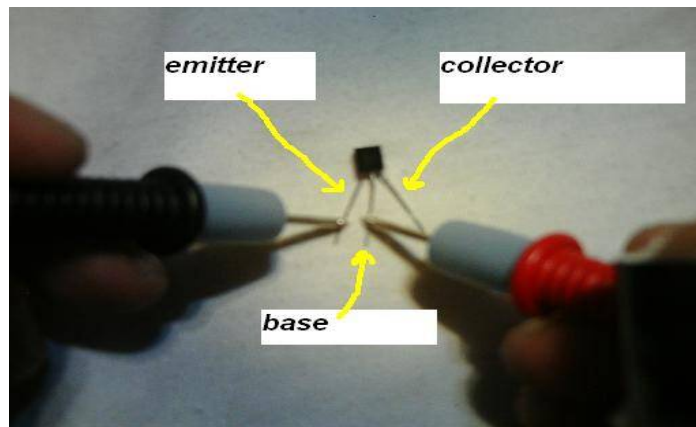

Step 1 Testing an PNP BJT With DMM

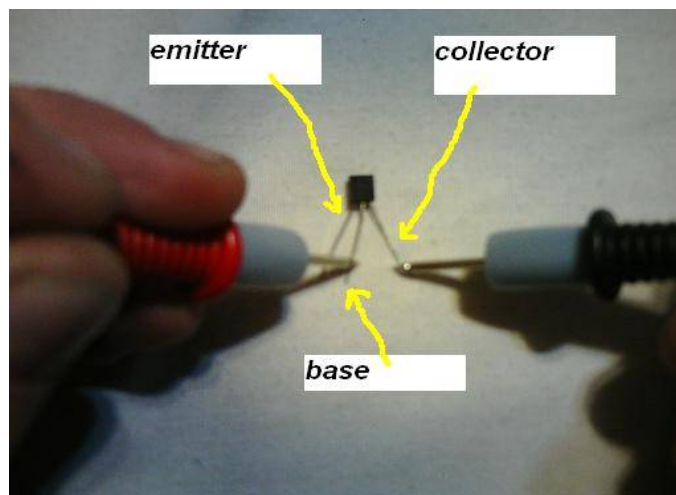

Step 2 Testing PNP BJT With DMM (Simply Repeat 1 & 2 With Test Leads In Reverse Polarity For Steps 3 And 4)

You can also use your analogue meter to test BJTs. Set your meter to the x1 ohm range and perform the test in the same manner as with the DMM only instead of a voltage drop reading you will be looking at a resistance reading and the test leads in the ohms range are reversed in comparison to a DMM the black test lead is positive and the red test lead is negative, but the idea is the same between base and emitter you should have a low reading in one direction and a high reading(infinity) in the other direction, same with the base and collector. You should get infinite reading in both directions between collector and emitter in the x1 ohm range.

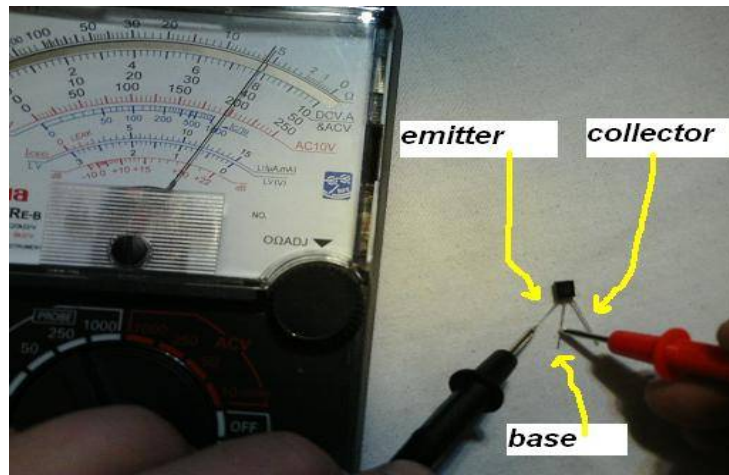

Testing PNP BJT with Analogue meter

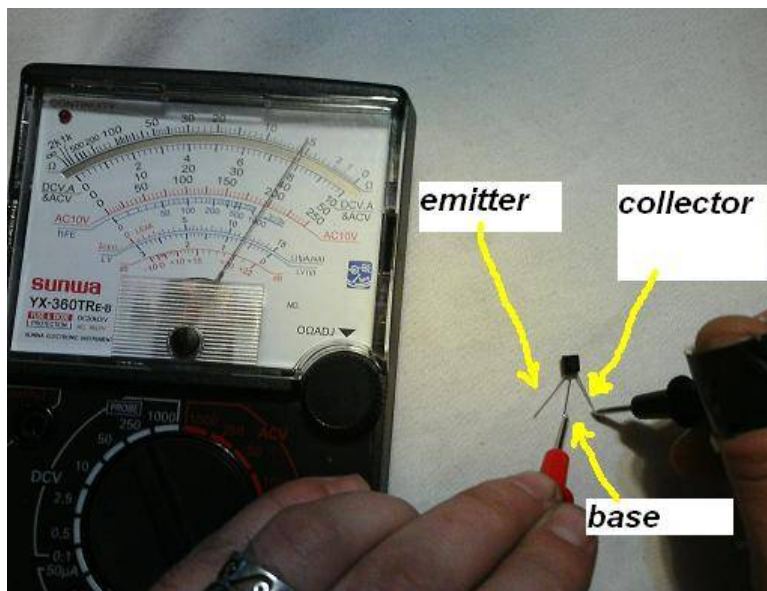

Testing PNP BJT with Analogue meter

Some DMM have a transistor test mode for checking h_{FE} (beta or gain). You can use this setting to test if a BJTs h_{FE} is within tolerance.



DMM h_{FE} Setting

MOSFETs-

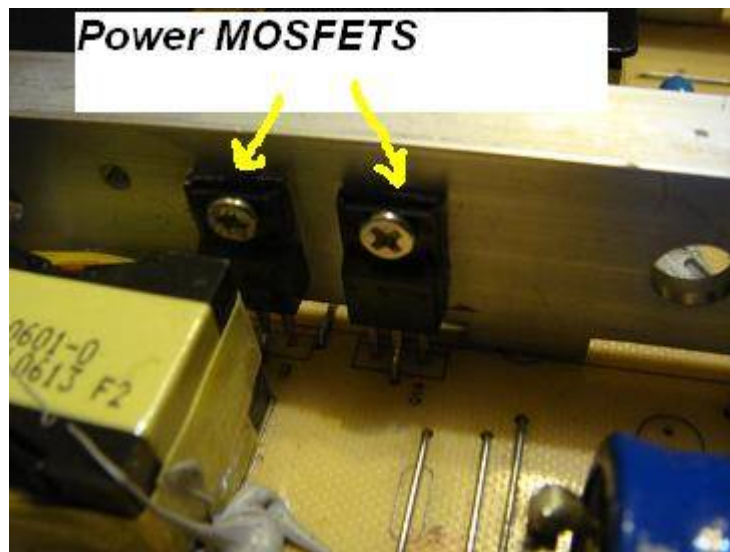

Power MOSFETS IN LCD PSU

The MOSFET or Metal Oxide Semiconductor Field Effect Transistor is a component similar to the BJT in the fact that it can amplify or switch electronic signals. The BJT relies on making a reverse biased junction conduct by applying an electronic signal to the other junction. The MOSFET or FET(Field Effect Transistor) is entirely different. In a MOSFET a strip of semiconductor material either n or p doped between the source and drain is made either more or less conductive by the presence of an electric charge between the gate and source.

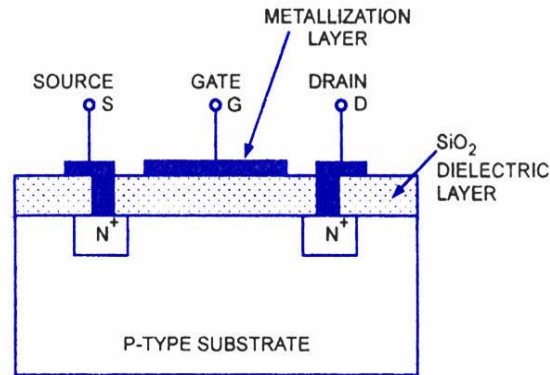

N-Channel E-MOSFET Structure

The MOSFET has three terminals or leads, the gate, source and drain. Both n channel and p channel devices are used in LCD TVs.

Special care must be taken(ESD Bracelet etc.) when handling small signal MOSFETs, because the gate is completely insulated from the source and drain by a very thin film of silicon dioxide. The insulation breaks down at roughly 20-100V depending upon the thickness of the silicon dioxide film.

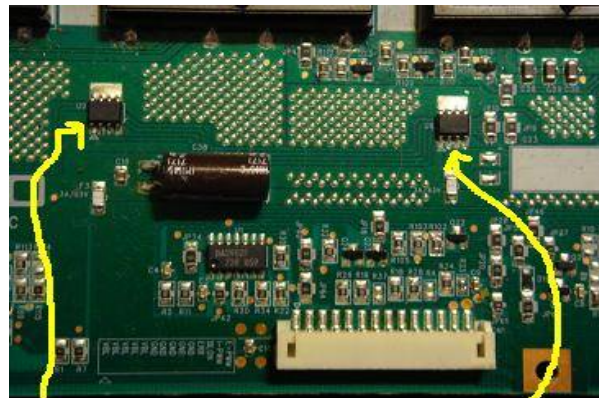

Dual MOSFET SMD ICs

MOSFET ICs on the inverter board.



MOSFET Schematic Symbol

Testing MOSFETs-

Once you have looked up the part number of the MOSFET you want to test online or in a parts reference manual or looked at the schematic diagram for the TV you are working on and know where all the pins are set your analogue meter to the x10k range to check the MOSFET. Let's say you are testing an n channel MOSFET, put the black test lead on the drain pin then touch the gate pin with the red test lead. This will discharge the MOSFET's internal capacitance. Next place the red test lead to the source pin while still holding the black test lead to the drain pin. Now take a finger, while still holding the test leads in place, red on source and black on drain, and use that finger to touch the gate and drain pin at the same time connecting them, the analogue meters needle should move from infinity to around the center position of the meters indicator. Taking the red test lead off the source pin and placing it back on the source pin the needle should still go back to the middle of the meters indicator. To discharge the MOSFET lift the red test lead from the source pin and touch it to the gate pin, this will discharge the internal capacitance again and if you again place the red test lead on the source pin and the black test lead to the drain pin, the needle on the indicator should not move and give an infinite ohms reading. Testing a p channel MOSFET is the same as for an n channel MOSFET only you will reverse the test leads. If all measurements taken from a MOSFET are low ohms or zero ohms reading on the indicator and the MOSFET will not discharge than the MOSFET is considered shorted.

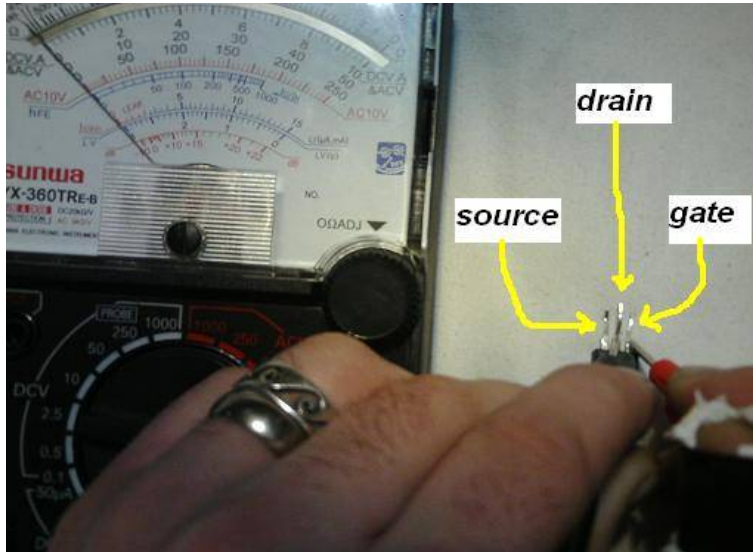

Step 1 Testing N Channel MOSFET

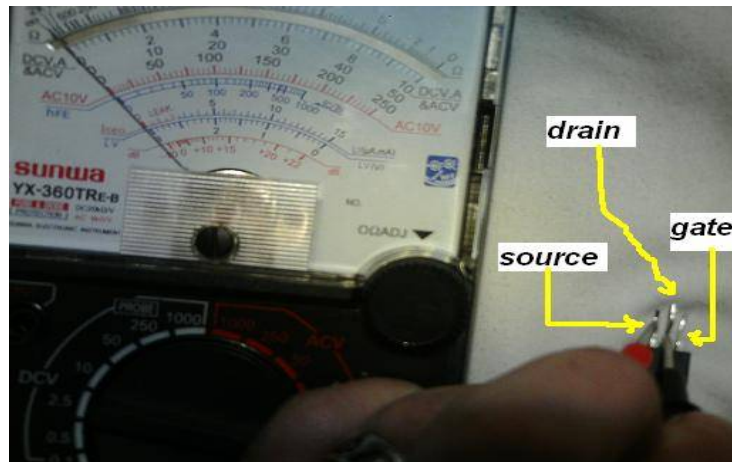

Step 2 Testing N Channel MOSFET

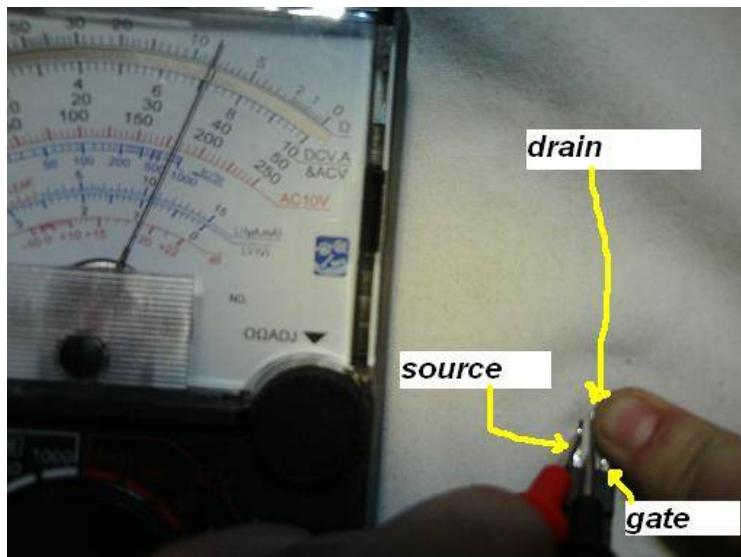

Step 3 Testing N Channel MOSFET

Special testing devices are available just for testing MOSFET transistors.



Alternative MOSFET Test Methods-

DE-MOSFET (Depletion/Enhancement Type,) Test Using an ohmmeter set to the x 100 ohm scale, measure the resistance between the MOSFET drain and the source, then reverse the ohmmeter leads and take another reading. The readings should be equal, regardless of meter lead polarity. Connect the positive lead of the ohmmeter to the gate. Using the negative lead, measure the resistance between the gate and the drain and between the gate and the source. Both readings should show infinity. Disconnect the positive lead from the gate and connect the negative lead to the gate. Using the positive lead, measure the resistance between the gate and the drain; then measure it between the gate and the source. Both readings should show infinity. If the MOSFET has a substrate connection, Disconnect the negative lead from the gate and connect it to the substrate. Using the positive lead, measure the resistance between the substrate and the drain and between the substrate and the source. Both of these readings should indicate infinity. Disconnect the negative lead from the substrate and connect the positive lead to the substrate. Using the negative lead, measure the resistance between the substrate and the drain and between the substrate and the source. Both readings should indicate a low resistance (about 1,000 ohms).

E-MOSFET (Enhancement Type, The most common type you will encounter)

Test Using an ohmmeter set to the x 100 ohm scale, measure the resistance between the drain and the source, then reverse the leads and take another reading between the drain and the source. Both readings should show infinity, regardless of meter lead polarity. Connect the positive lead of the ohmmeter to the gate. Using the negative lead, measure the resistance between the gate and the drain and then between the gate and the source. Both readings should indicate infinity. Disconnect the positive lead from the gate and connect the negative lead to the gate. Using the positive lead, measure the resistance between the gate and the drain and then between the gate and the source. Both readings should indicate infinity. If the MOSFET has a substrate connection, Disconnect the negative lead from the gate and connect it to the substrate. Using the positive lead, measure the resistance between the substrate and the drain and between the substrate and the source. Both of these readings should indicate infinity. Disconnect the negative lead from the substrate and connect the positive lead to the substrate. Using the negative lead, measure the resistance between the substrate and the drain and between the substrate and the source. Both readings should indicate a low resistance (about 1,000 ohms).

You should always try and find a data sheet for the MOSFET you are testing because you will find some MOSFETs will have different characteristics that will make the test readings slightly different. For instance the P11NK50Z has a diode between source and drain, so that when testing you will get a reading in one direction between source and drain in x100 ohm setting and this is normal.

Understanding and Testing Diodes

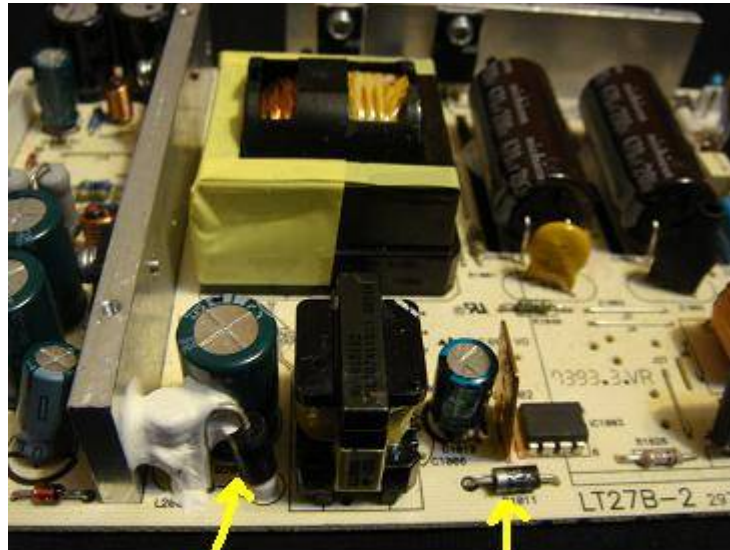

Schottky Diode

Diode

Diodes In LCD TV Standby Circuit

A diode is a two terminal electronic component that allows electric current to flow in only one direction. The word diode is usually associated with the semiconductor diode which is the most common diode in use at the time I am writing this. The semiconductor diode is made up of a pn junction.

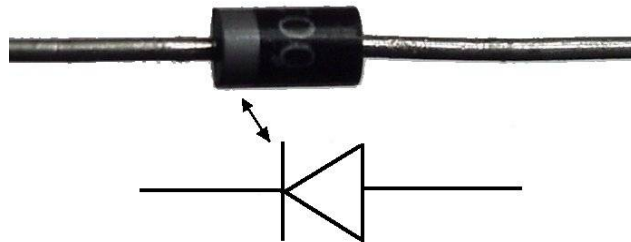

Rectifier Diode Shown Next To Schematic Symbol

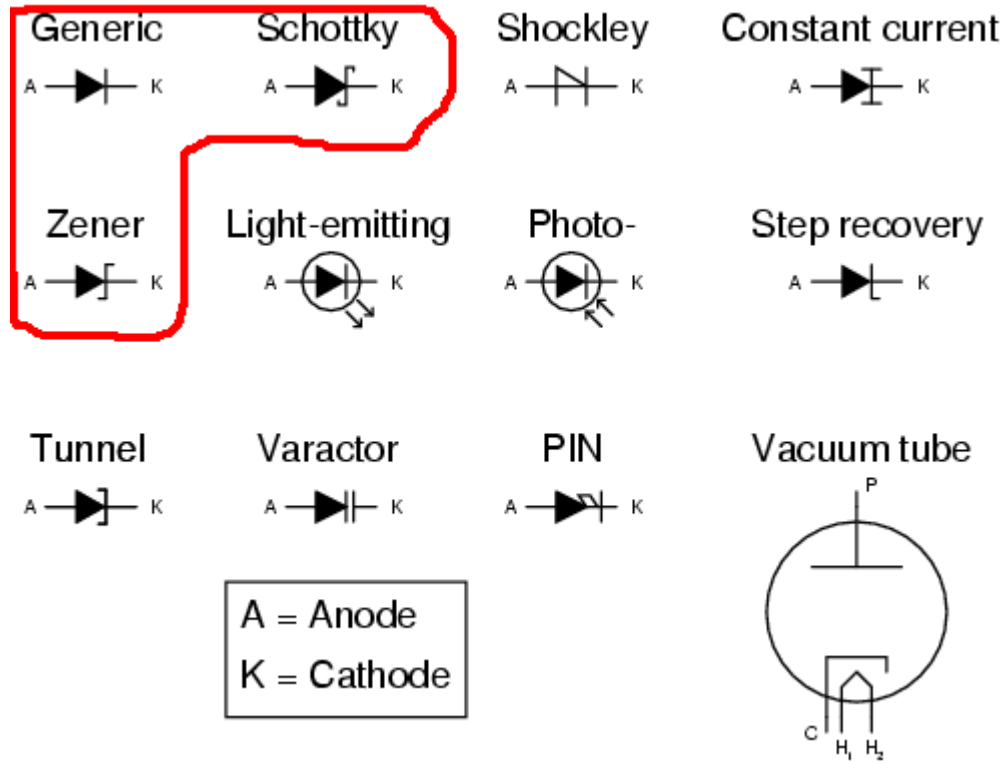

Schematic Symbols For Different Types Of Diodes

Testing The Diode-

Using your DMM set to the diode test mode, place the black test lead on the cathode(marked with a band) lead of the diode and the red test lead on the anode.



You should get a voltage drop reading of between 0.45-0.7. Reverse the test leads so that the red test lead is on the cathode and the black test lead is on the anode and you should get an O.L. Reading.

If you get a low reading in both directions the diode is considered shorted and if you get an O.L. reading in both forward and reverse bias directions the diode is considered open, in both cases the diode must be replaced. Most commonly diodes will be shorted.

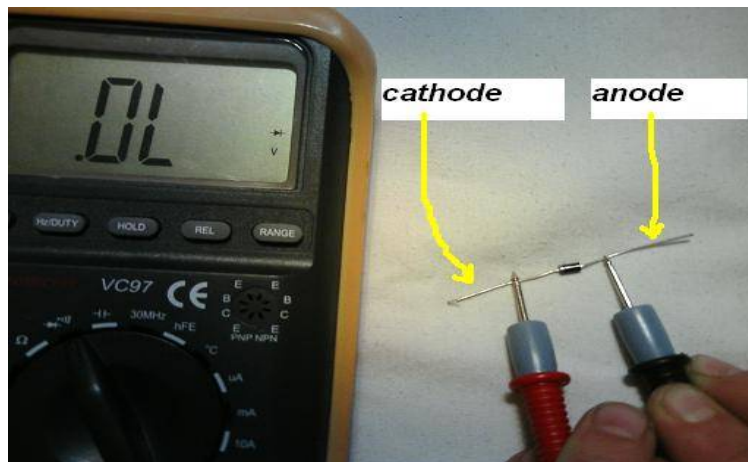

Step 1 Testing Diode With DMM

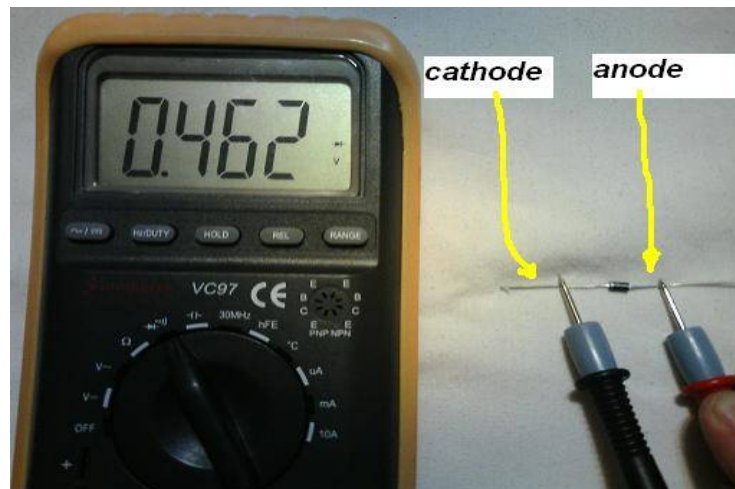

Step 2 Testing Diode With DMM

Testing Diodes With analogue Meter-

Using your analogue meter set to the x1 ohm range place the red test lead on the cathode and the black test lead on the anode, you should get a low ohms reading and reversing the test leads you should get a reading of infinity.

Now set the meter to x10k range and repeat the same test, you should get the same results. If when you have the red probe on the anode and the black probe on the cathode in the x10k range you get any reading the diode is leaky and must be replaced.

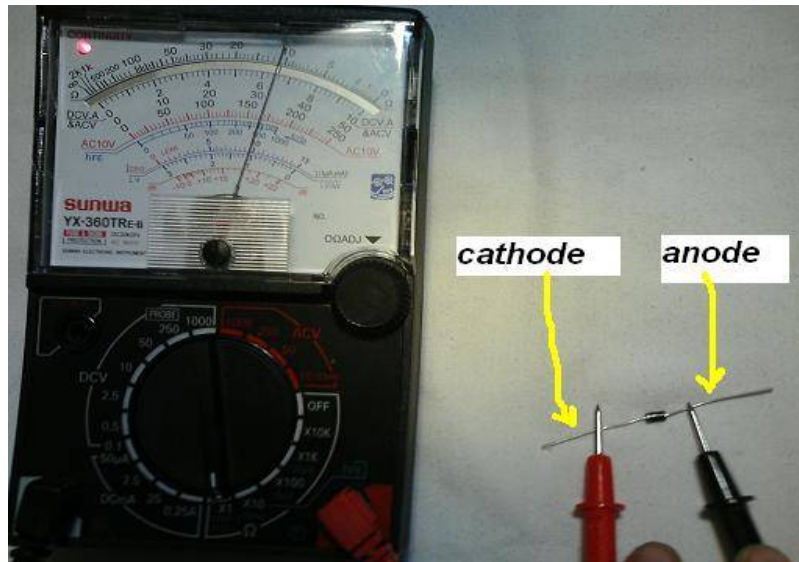

Step 1 Testing Diode With Analogue Meter Set To x1 ohm Range

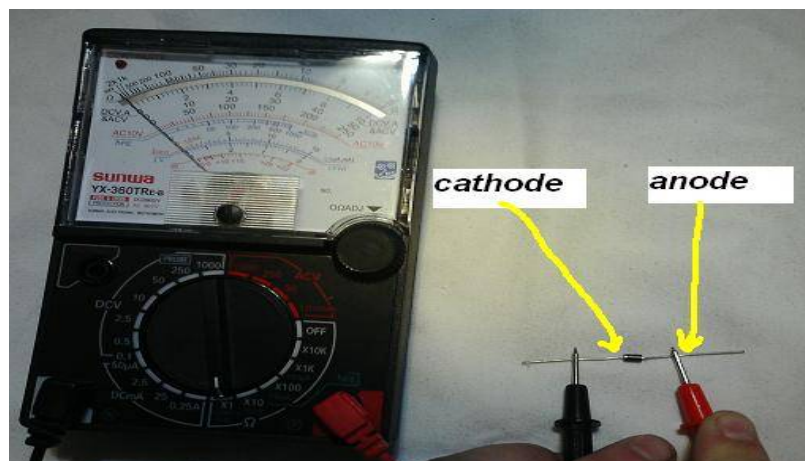

Step 2 Testing Diode With Analogue Meter Set To x1 ohm Range

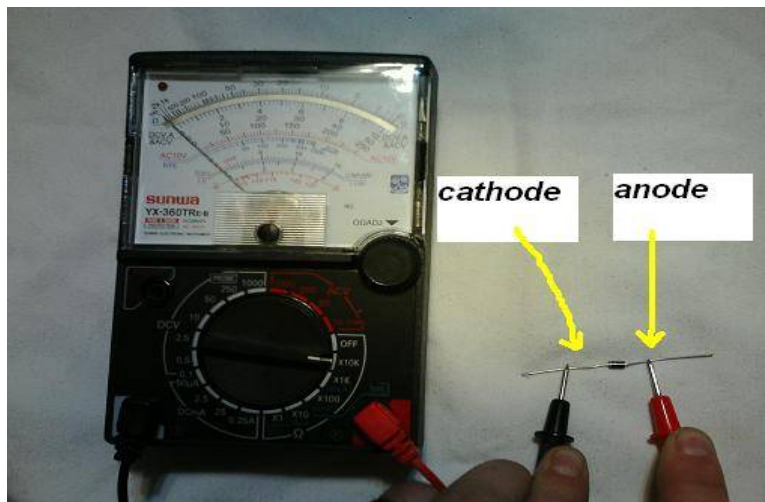

Step 1 Testing Diode With Analogue Meter Set To x10k ohm Range

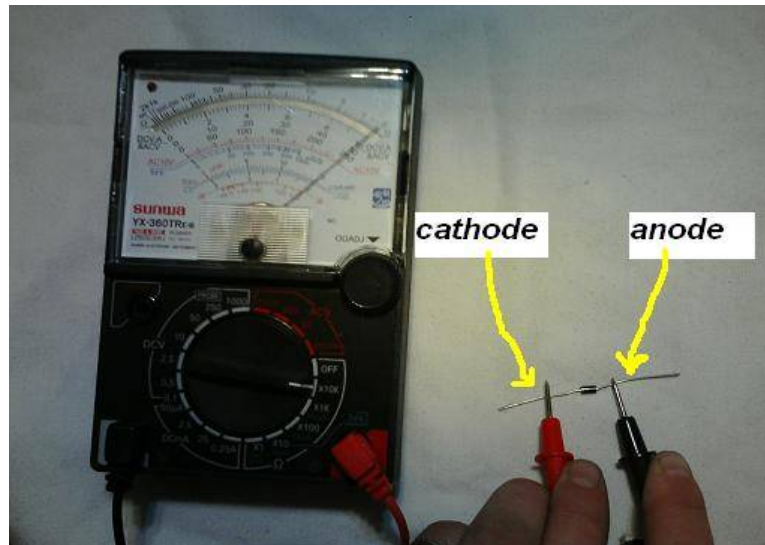

Step 2 Testing Diode With Analogue Meter Set To x10k ohm Range

Schottky Diodes-

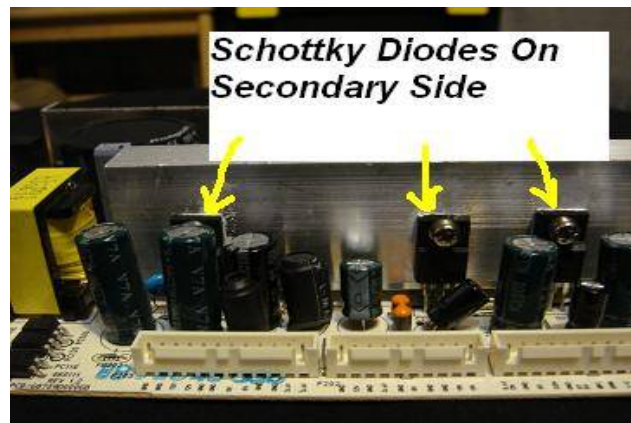

Schottky Diodes In LCD TV SMPS

Schottky diodes also known as hot carrier diodes are semiconductor diodes with a lower forward voltage drop than a standard diode and a very fast switching action. When a current flows through a diode there is a voltage drop which as stated earlier is about 0.45-0.7V for normal diodes, but a schottky diodes voltage drop is between 0.15 and 0.45V, the lower voltage drop means higher circuit efficiency. The most important feature of the schottky compared with the normal pn diode is reverse recovery time, the time it take to switch from conducting to nonconducting and nonconducting to conducting. Schottky diodes can look very similar to normal diodes in design. Often they come in a dual package with the two diodes cathodes being common.

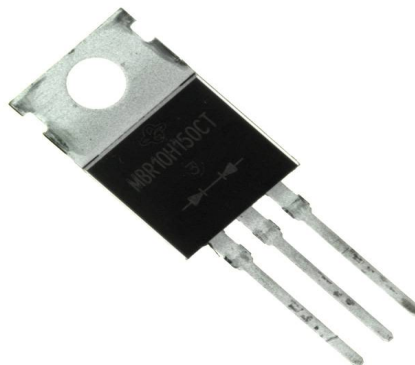

Dual Package Schottky

Testing Schottky Diodes-

Once you know the diode you are going to test is a schottky than you need to use your analogue meter and set it to the x10k ohm range. Testing is similar to the normal diode only you will get a reading in both directions. This is a normal characteristic of a schottky diode. The reading should be full scale deflection with the red test lead on the cathode and the black test lead on the anode, then with the black test lead on the cathode and the red test lead on the anode you will get a small leakage reading. If you get two full scale deflection readings the schottky diode is shorted and needs to be replaced, if the reading is infinite in both directions the schottky diode is open and must be replaced. Testing the schottky in the x1 ohm range will be just like testing a normal diode, also note that not all schottky diodes will give a reading in both directions when set to x10k but just be aware that this kind of diode can have a reading in both directions when measuring in the x10k setting unlike a normal diode.

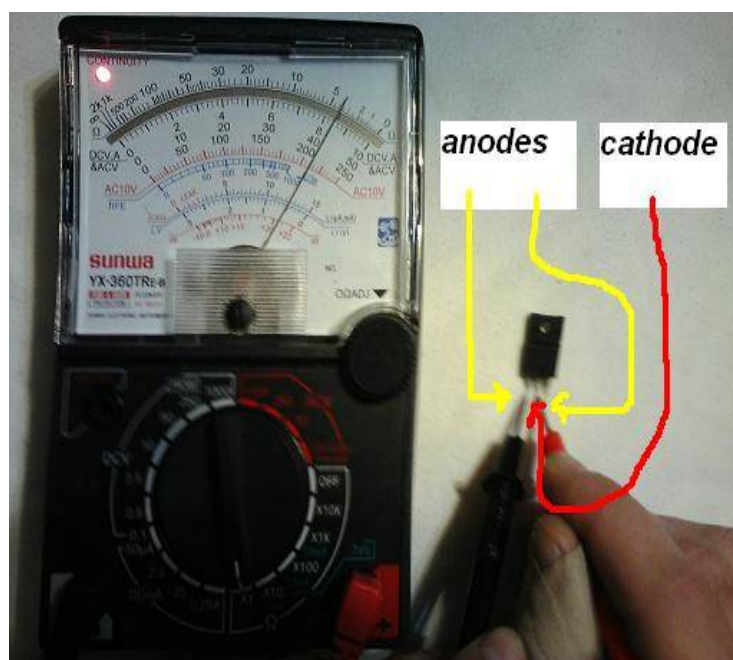

Step 1 Testing Schottky Diode In x1 ohm Setting

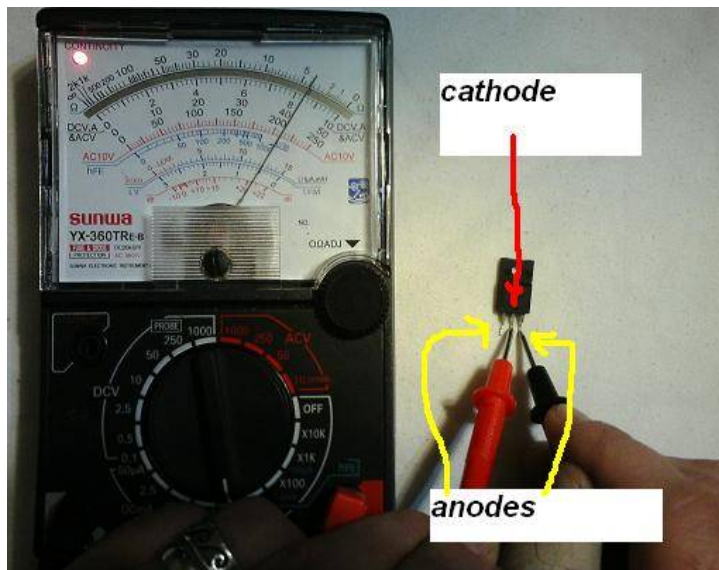

Step 2 Testing Schottky Diode In x1 ohm Setting

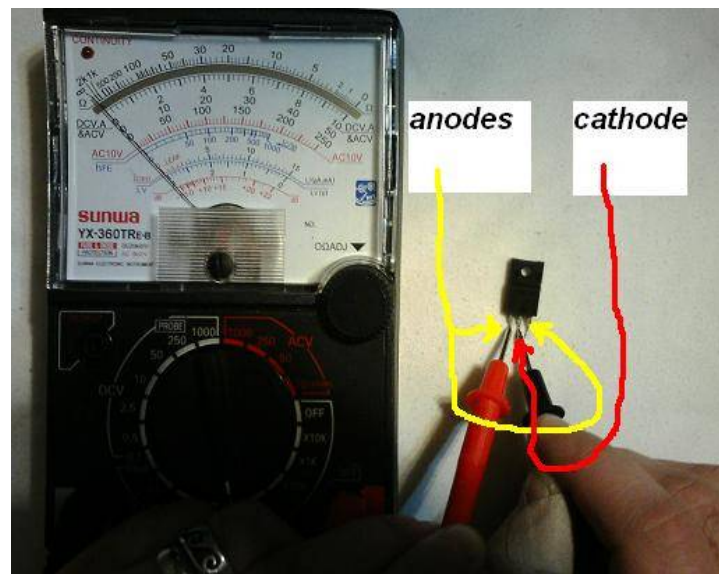

Step 3 Testing Schottky Diode In x1 ohm Setting

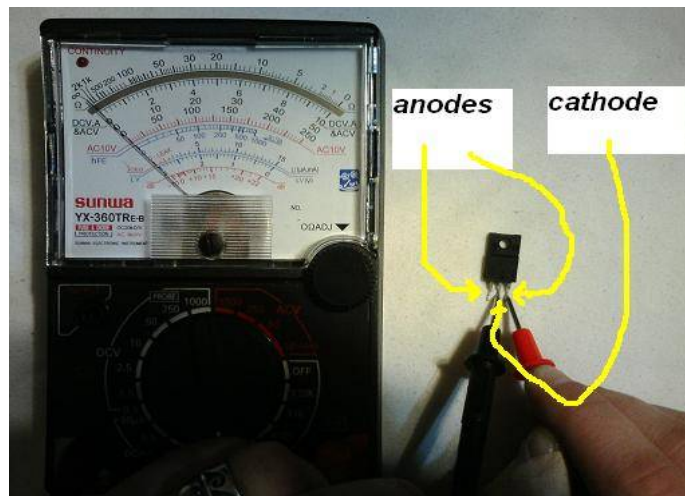

Step 4 Testing Schottky Diode In x1 ohm Setting

Zener Diodes-

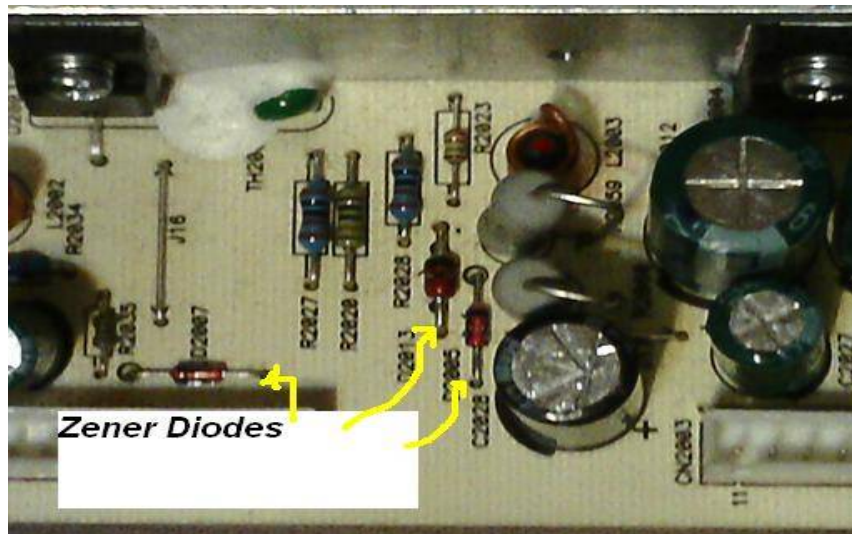

Zener Diodes In LCD TV SMPS Secondary side

A zener diode is a diode that not only permits current flow in the typical direction but also in the bias direction when the voltage applied is greater than the breakdown voltage called the zener voltage. A zener diode exhibits very similar properties to that of a normal diode except it is specially designed to have a low reverse breakdown voltage or zener voltage. This is done by heavily doping the pn junction of the diode. Doping is the process of introducing specific amounts of impurities to the semiconductor material for the purpose of changing its conductivity. The breakdown voltage of zener diodes can be controlled quite accurately through the process of doping. Common breakdown voltages range from around 1.2V to 200V. Zener diodes are normally used as a voltage reference or as shunt regulators for voltage regulation in smaller circuits because of their ability to maintain a fairly constant voltage drop with a varying current.

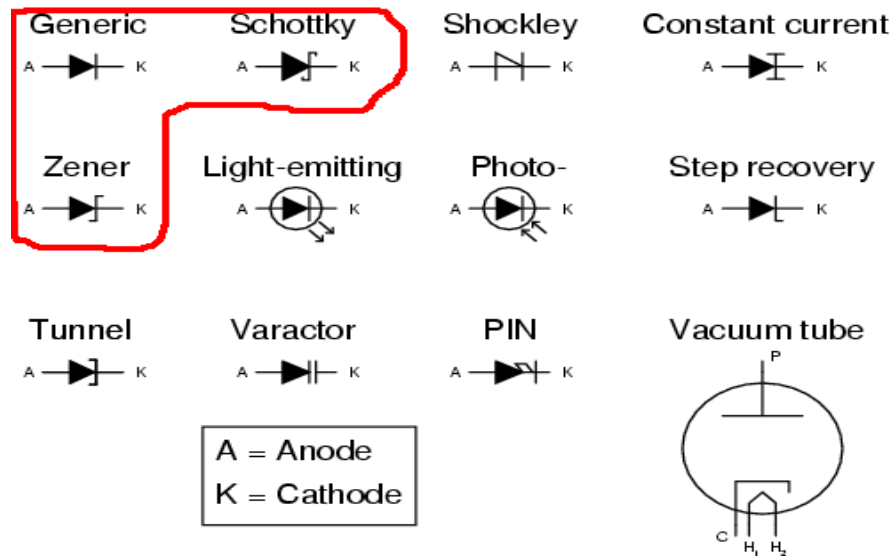

Testing Zener Diodes-

Testing zener diodes is best done with a zener diode tester.



Zener Diode Tester

Although another process that can be used is found in this book “[Testing Electronics Components](#)”



Another method for testing zener diodes involves the use of a variable DC power supply and an ammeter.

Connect the zener diode you want to test in series with a resistor to limit current flow through the testing circuit(the value of the resistor will depend on the zener diode and how much current it is rated for). Then connect the ammeter of proper size or the current setting of your DMM set to the proper range in series with the zener diode and resistor. Connect the cathode end of the diode to the positive terminal of the variable DC power supply and the free anode to the negative terminal of the DC power supply. Turn on the variable DC power supply and slowly increase the voltage. No current should flow through the circuit as indicated by the ammeter until the voltage is raised to the breakdown voltage of the zener diode under test.

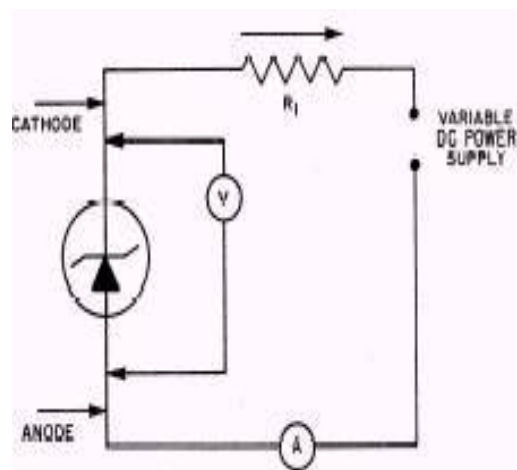

Example Zener Diode Test Circuit

Understanding and Testing Bridge Rectifiers



Bridge Rectifier

Bridge Rectifier In LCD TV PSU

The purpose of the bridge rectifier is to convert AC voltage into DC voltage.

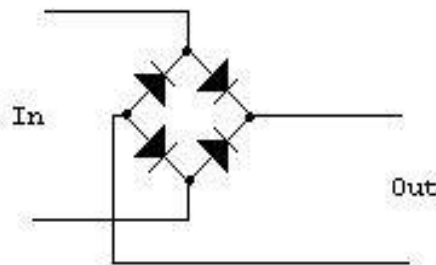

Symbol For Bridge Rectifier

A bridge rectifier is an arrangement of four diodes in a bridge configuration and commonly comes in one integrated package containing all four diodes. A diode bridge or a bridge rectifier give full wave rectification.

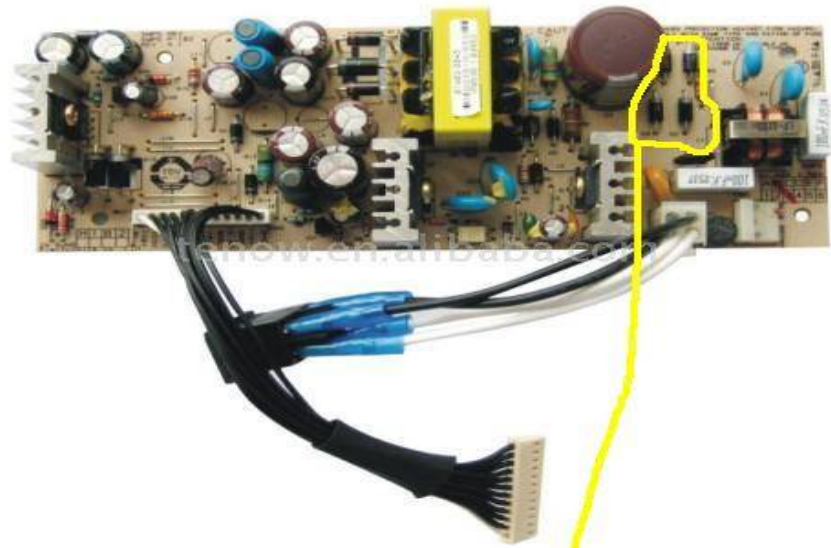

Four Diode Bridge In PSU



Bridge Rectifier IC

Testing Bridge Rectifiers-

Using your analogue meter set to x10k ohms range place the test leads to the negative and the first AC pin and then reverse the leads, you should show a low resistance in one direction and infinite in the other direction. Next do the same test with the negative pin and the second AC pin the results should be the same. Now do the same tests only with the positive pin and both the AC pins, the results should again be the same. If you find low ohms reading in both directions on any of these tests then the bridge rectifier must be replaced, also if you get an infinite reading in both directions the bridge rectifier must be replaced. If instead of a bridge rectifier in integrated package you find four individual diodes in a bridge configuration, test each diode individually and if even one diode is faulty replace all four.



Step 1 Testing Bridge Rectifier IC



Step 2 Testing Bridge Rectifier IC



Step 3 Testing Bridge Rectifier IC



Step 4 Testing Bridge Rectifier IC

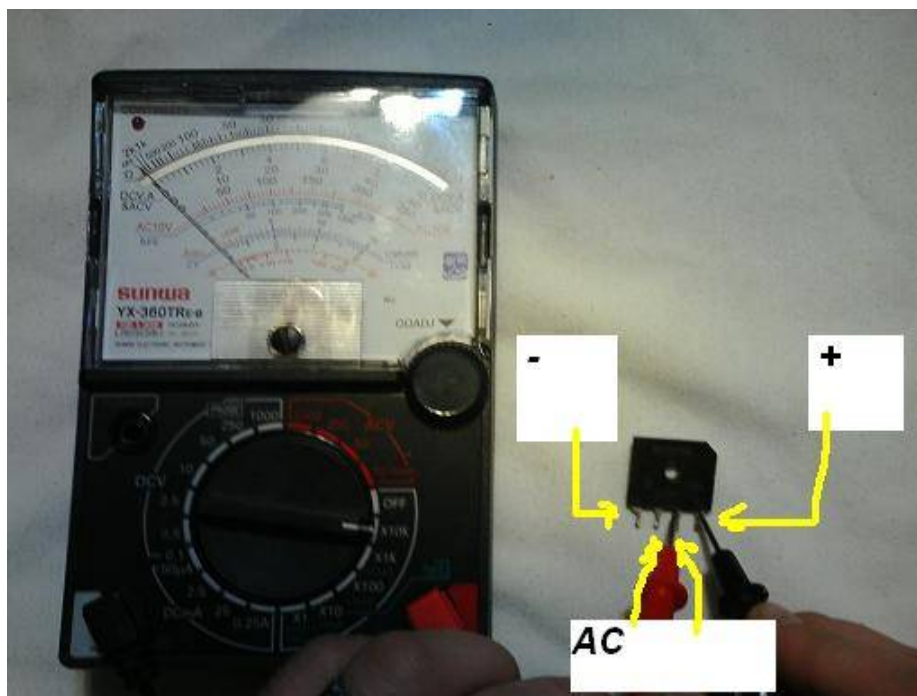

Step 5 Testing Bridge Rectifier IC



Step 6 Testing Bridge Rectifier IC

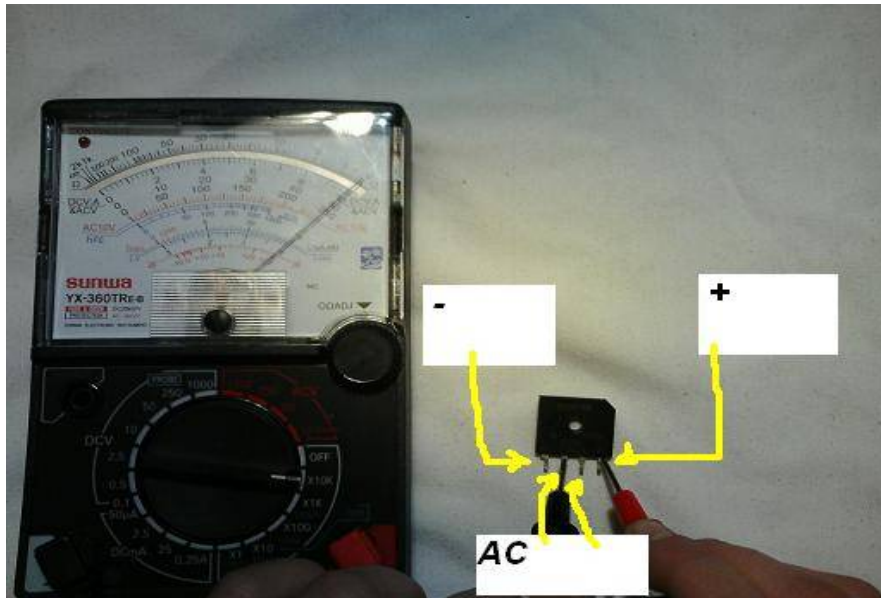

Step 7 Testing Bridge Rectifier IC



Step 8 Testing Bridge Rectifier IC

Understanding and Testing LEDs

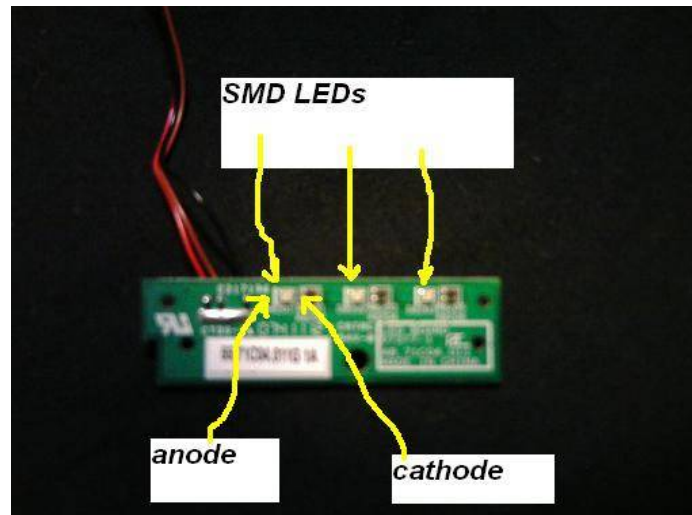

LEDs On LCD TV Status Board

An LED or Light Emitting Diode is a semiconductor component source of light. LEDs are used as indicator lights in LCD TVs. The LED is based on the technology of the semiconductor diode, when an LED is forward biased (turned on) electrons recombine with holes inside the component creating an effect called thermoluminescence.

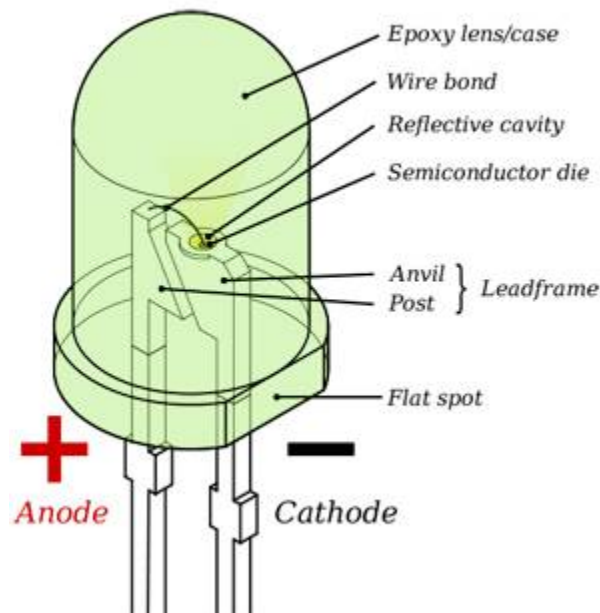



Up close Picture of SMD LEDs

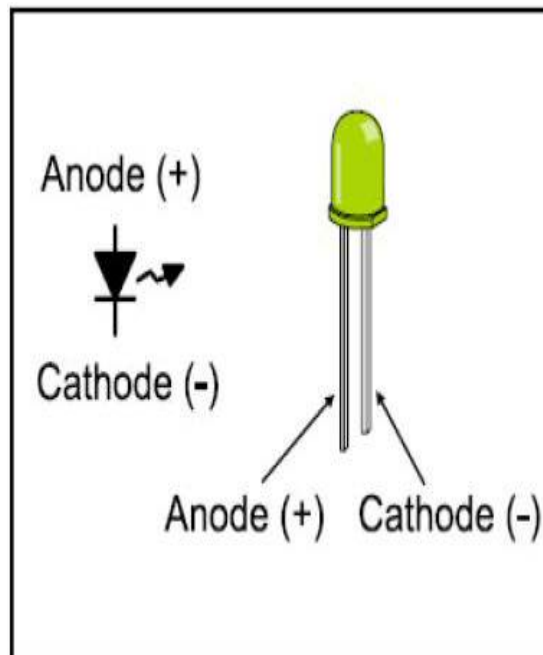

Schematic Symbol In Comparison With Physical LED

Testing LEDs-

Testing an LED is very simple, it will emit light when forward biased and will not emit light when reverse biased. If an LED does not light when forward biased then it has gone open circuit and must be replaced. To test, set your analogue meter to x1 ohm range. Place the red test lead on the cathode pin this side is indicated by a flat spot on the plastic package or a line on SMD packages, the anode side will not have the flat spot. While the red test lead is on the cathode touch the black probe to the anode pin and the LED should light, remove lead quickly after LED lights so as not to damage it.

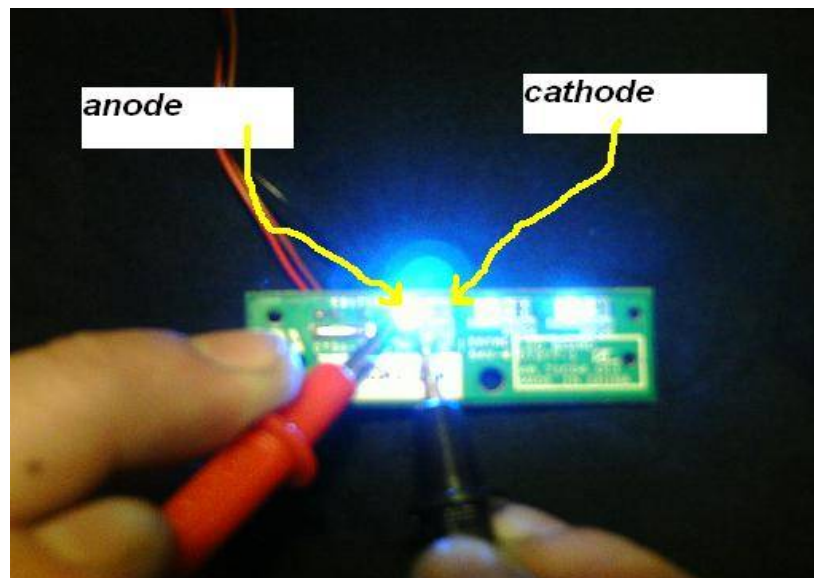

Testing SMD LED On LCD TV LED/Status Board

If you reverse the test leads the diode will not light.

Understanding and Testing Switching Transformers

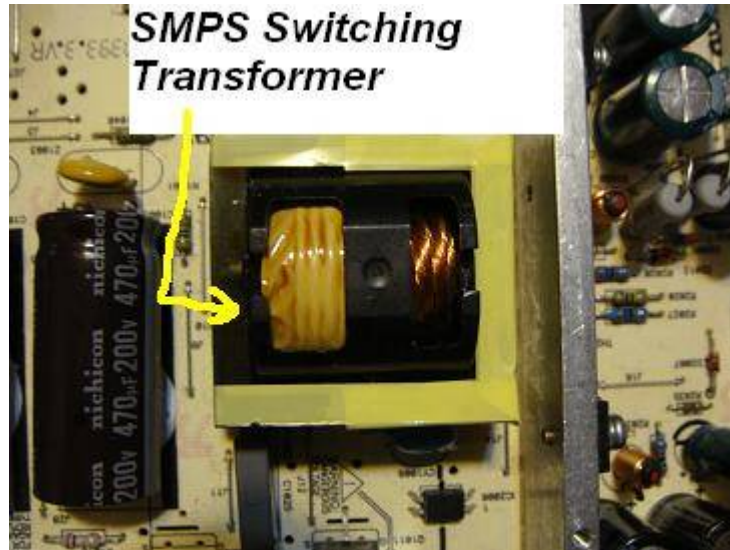

Switching Transformer In LCD TV PSU

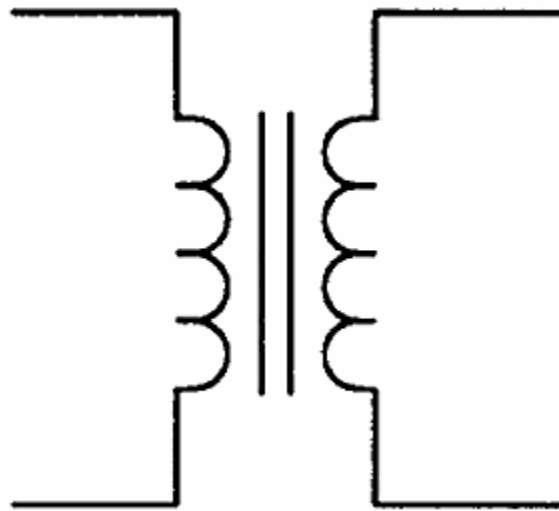

Basic Transformer Schematic Symbol

Switching transformers are found in the SMPS of LCD TVs(The high voltage transformers on the inverter board are also a type of switching transformer that we will discuss later). The function of the switching transformer is to convert a voltage applied across it's primary winding into a lower or higher voltage across it's secondary windings depending on the amount of turns in the primary and secondary windings of the switching transformer. Switching transformers are robust components and rarely breakdown, and when it does it will normally cause components in the primary side of the switching transformers circuits that drive it's primary to blow/fail, as well and most likely blow the main fuse. The most common failure is a shorted primary winding. The secondary windings seldom have issues in the LCD TV SMPS due to the fact that they step down voltage and the secondaries have very few windings, The primary however has many winding. To test the primary winding of the switching transformer use a ring tester. Locate the primary winding pins by first following the trace from the positive pin of the reservoir capacitor will lead you to the first pin.

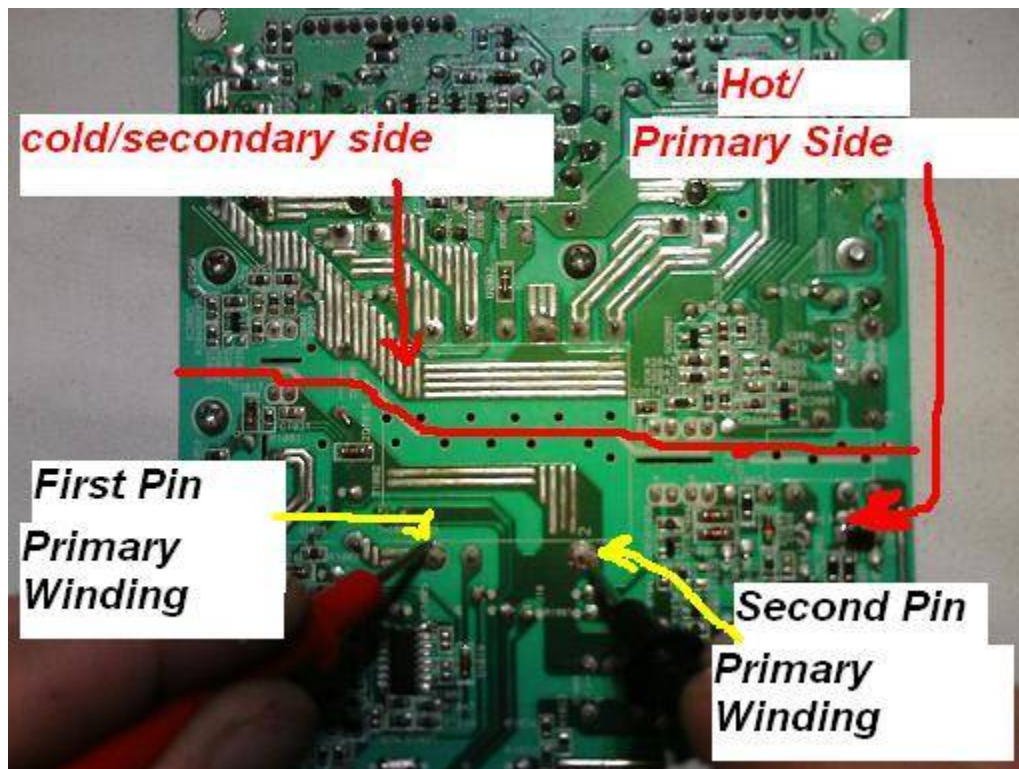

Next follow the trace from the power MOSFET/s source to the next pin of the primary winding. Place the test leads of the ring tester to these two pins. Most switching transformers will light up four to eight LEDs, of course if you can, check your reading against that of known good switching transformer that is the same exactly as the suspected one under test, of course this normally is not possible, so if you only light up one to two or no LEDs it is most likely that the switching transformer has shorted windings and needs to be replaced. If the switching transformer tests bad always remove it from the circuit board and test again to be sure. If it tests good out of circuit suspect other failed components in the SMPS perhaps a shorted secondary side diode. If a switching transformer is found to be bad you may have trouble finding an exact replacement and you may have to find a company or person online that will rewind it for you

or you can attempt to rewind it yourself with instructions found online. You can also check switching transformers for an open primary winding although it is not a common failure. Set your DMM to the ohms setting or your analogue meter to x1 ohm range. Check for a low ohms reading across the primary winding. If the reading is O.L. Or infinity than the winding is considered open and the transformer must be replaced or rewound.

You can also check the secondary windings to make sure they are not open and if you have another of the same switching transformer to compare with you can ring the secondary windings as well although because they have less windings they will not light up as many LEDs, even only one LED or none and this is normal. If you get no rings on the secondary windings you can also check them with an ESR meter to compare with another transformer, since the windings have reactance they will give high ESR reading on the ESR meter, if you get zero ohms on the ESR meter this could be a sign of shorted secondary windings. Another test is to set your analogue meter to the x10k ohms range and place one test lead on a pin of the primary side and the other lead touch to the pins on the secondary side. You should not get any reading between the primary and secondary windings.

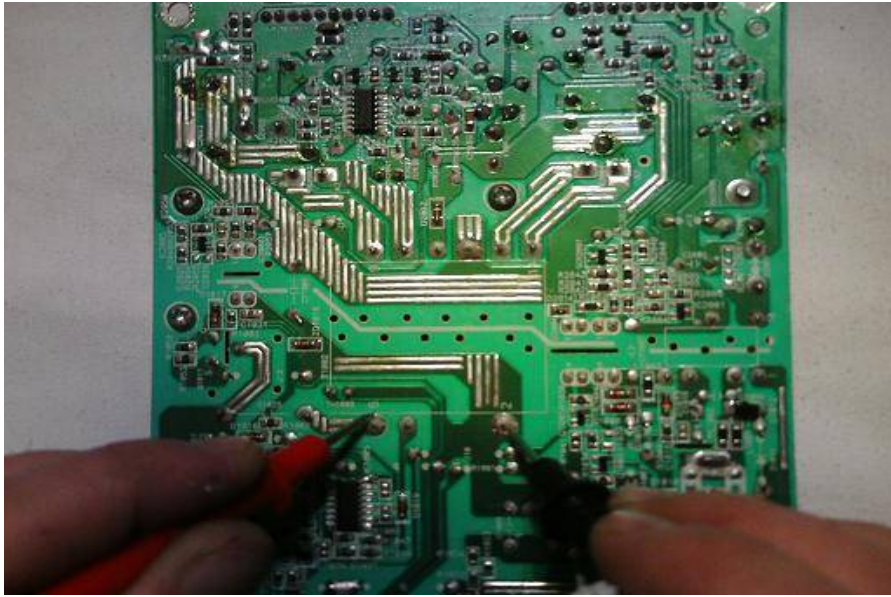

Checking For Open Primary Winding In SMPS Switching Transformer

Understanding and Testing Opto-Isolators

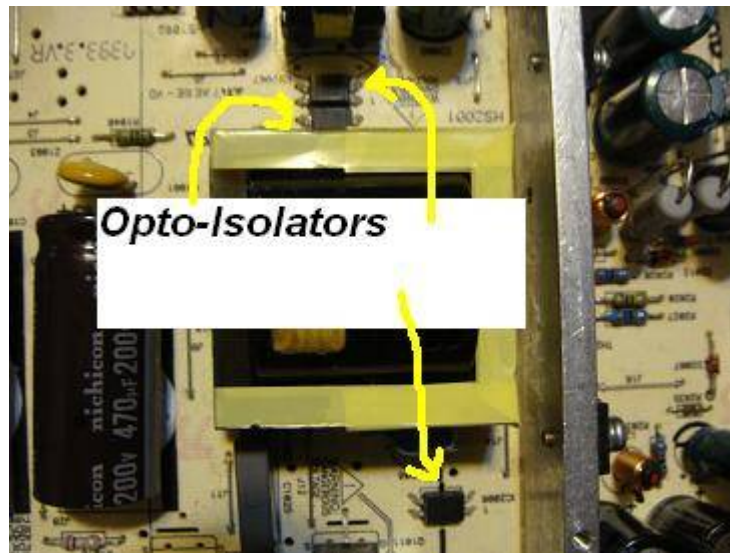

Opto-isolators In LCD TV SMPS

An opto-isolator also called an opto-coupler or photo-coupler is a component that allows a signal to pass from one circuit to another but allows the two circuits to remain electrically isolated. The most common opto-isolator which comes in IC package consists of an LED which shines onto the base of a photo-transistor, usually an npn transistor. A signal is applied to the LED which then shines light that is varied in brightness with the same amplitude as the input signal. This light lands upon the photo-transistor which passes the signal onto the next circuit.

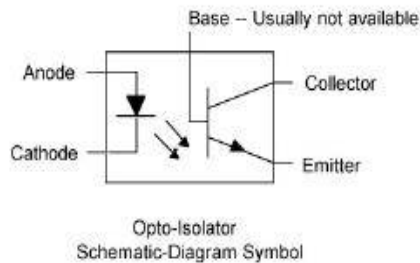
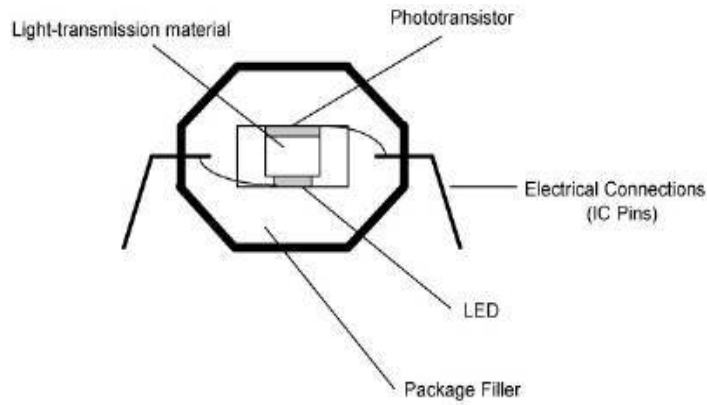

Testing Opto-Isolators-

Using your analogue meter set to the x1 ohm range test the LED side of the opto-isolator. Which will be found be looking up the part number online or referring to the LCD TVs schematic. A common opto-isolator found in LCD TVs is the 817 type for instance the PC817.

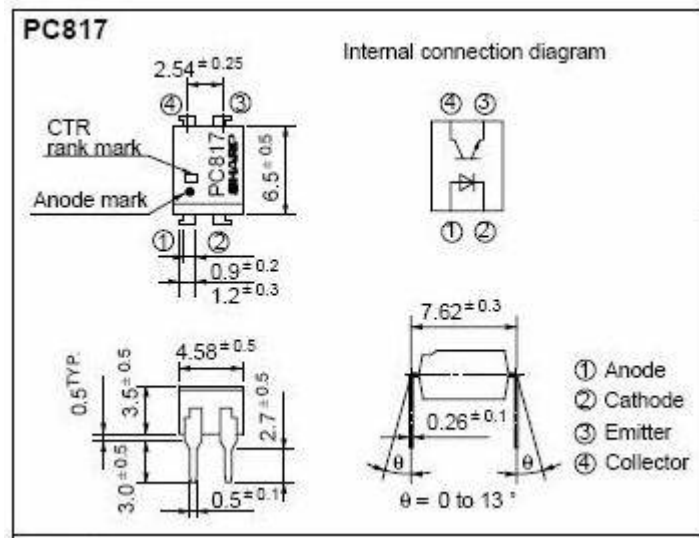

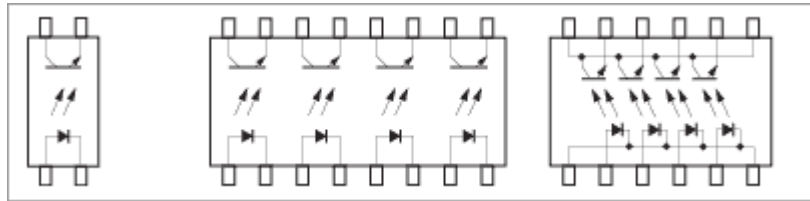

Multiple Package Types

Placing the test leads on both pins of the LED side of the opto-isolator and then reversing them you should get a low ohms reading in one direction and infinite reading in the other. If you get a low ohm reading in both directions the LED side is shorted and the opto-isolator needs to be replaced. If you get an infinite reading in both directions, the LED side is open and again the opto-isolator must be replaced.

Next you must test the transistor side of the opto-isolator. Some opto-isolators will have six pins in which case the three pins that correspond to the transistor side of the IC will be base, emitter and collector and on the LED side the three pins will be the anode, cathode and one pin with no connection. If you have a six pin opto-isolator, refer to the section of this book on testing transistors to check the transistor side. If you have a four pin opto-isolator which I find is most common in LCD TVs, then set your analogue meter to the x10k ohm range and place the test leads on the two pins of the transistor side which will be the emitter and collector and then reverse the test leads. You should get a high ohm reading with the test leads in one direction and an infinite reading in the other direction.

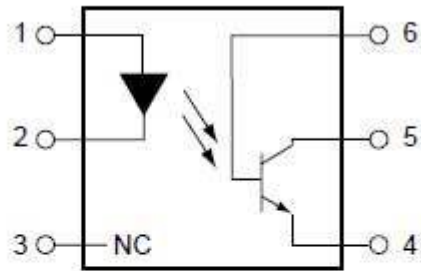

- PIN 1. ANODE
- 2. CATHODE
- 3. NO CONNECTION
- 4. EMITTER
- 5. COLLECTOR
- 6. BASE

Six Pin Opto-isolator

If you get a high ohm reading or low ohm reading in both directions the opto-isolator must be replaced. Now set the meter to x1 ohm range and place the test leads on the emitter and collector in both directions again, now you should get only an infinite reading in both directions, otherwise the opto-isolator must be replaced.

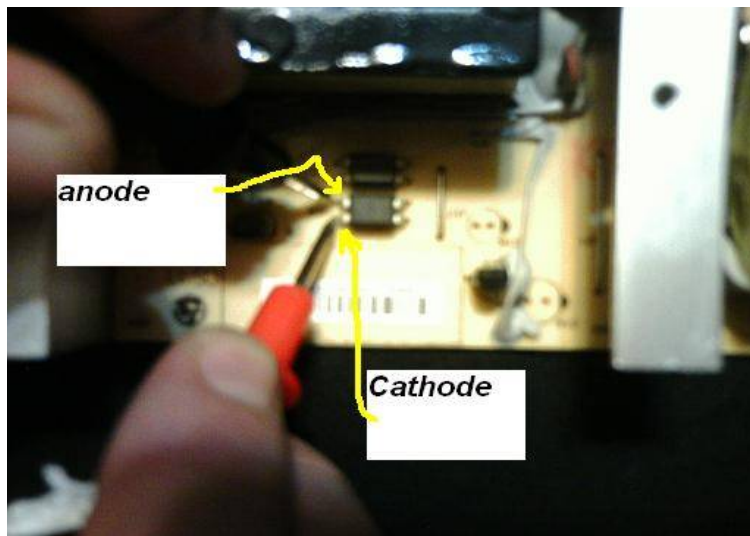

Step 1 testing LED side

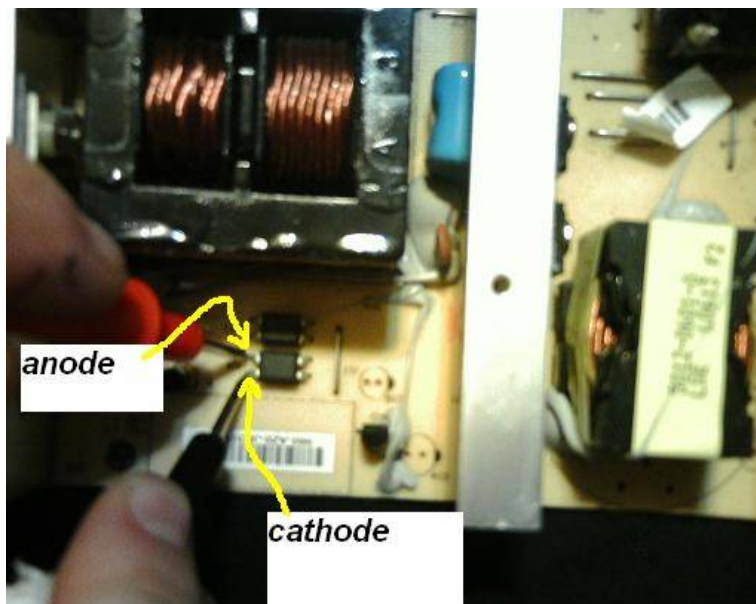

Step 2 testing LED side

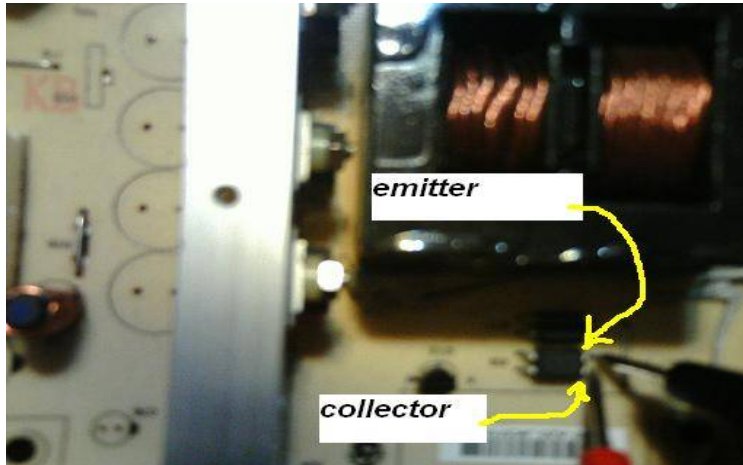

Step 3 testing transistor side

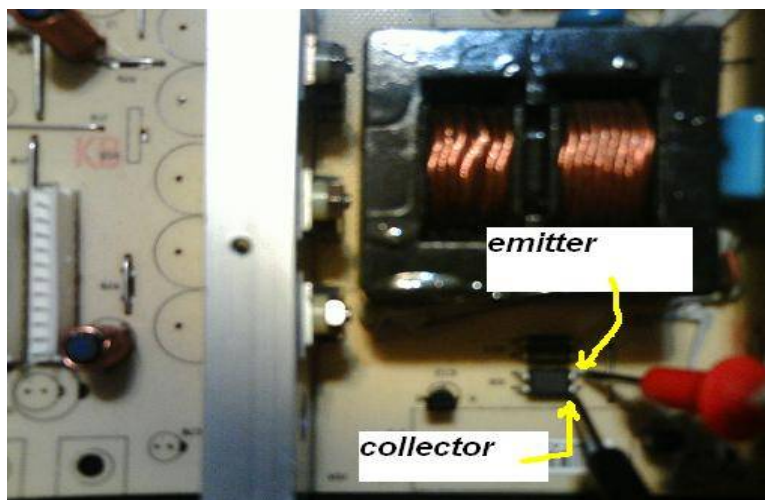

Step 4 testing transistor side

Understanding and Testing Voltage Regulators

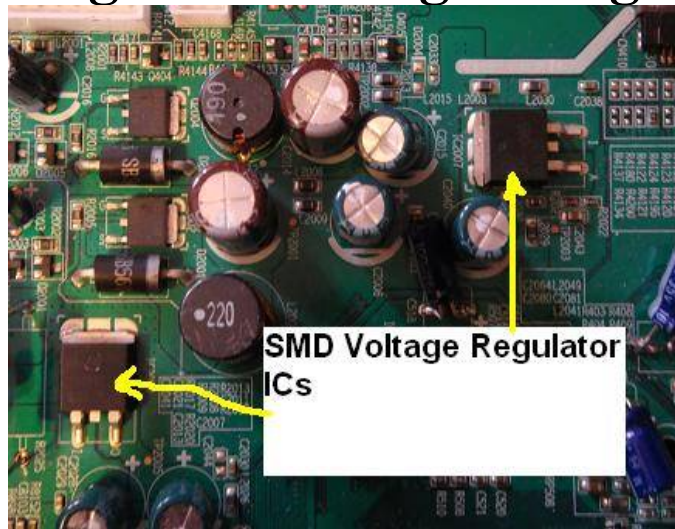

Voltage Regulator ICs on LCD TV Main Board

A voltage regulator is an electronic circuit designed to automatically maintain a constant output voltage regardless of fluctuations in input voltage or current draw from the load(to an extent).

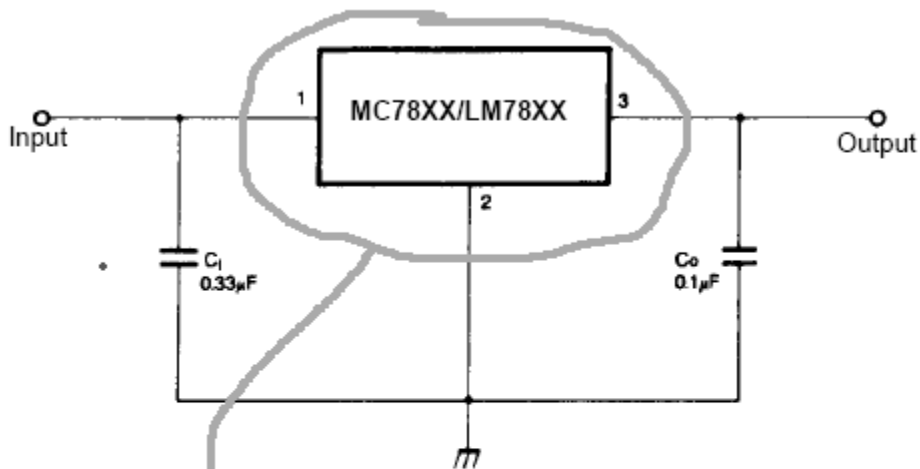
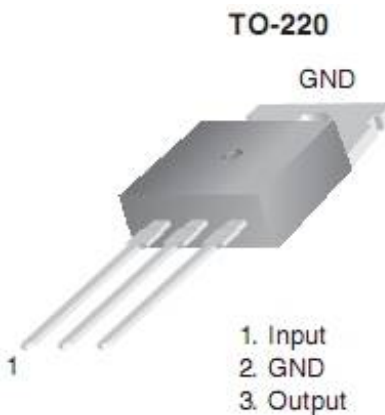

Figure 5. DC Parameters

Voltage Regulator IC Schematic Symbol

Testing Voltage Regulator IC-

To test the voltage regulator IC you must check it in circuit with the TV plugged in and or power on to the LCD TV. Power the TV on and set your DMM or analogue meter to the proper DC voltage setting. Place your black test lead to cold ground and carefully place your red test lead to the output pin of the regulator, usually pin three on many voltage regulators, like the LM7805. Remember to always look up your part numbers for the part you are testing if needed so you can be sure to test it properly.



Typical LM7805 Package

Now you should expect the output voltage to be within tolerance of the regulators specified voltage. So for an LM7805 you should expect about 5.1-5.9V DC, if you measure a low voltage like say 1V you should turn the TV off and unplug it then lift the output pin of the regulator from the circuit. Then power the TV on again and retest checking the voltage right on the lifted pin, If the voltage is back to around 5V again instead of 1V then the IC is most likely good and you should suspect shorted components in the circuit after the regulator that are pulling down the voltage. If the voltage is still low then the regulator is most likely bad and needs to be replaced (granted the input voltage is good). If you measure OV on the output and even in the case we just discussed you should also check the voltage on the input of the voltage regulator and make sure it is at least the regulation voltage plus the regulators “drop out” voltage. The drop out voltage is the voltage that the input must be above the regulation voltage for the given regulator, to maintain a regulated output. For instance if a LM7805 had a drop out voltage of 2V then it would require at least a 7V input to maintain a 5V regulated output. If the input voltage is low suspect bad components in the circuit feeding the regulator.

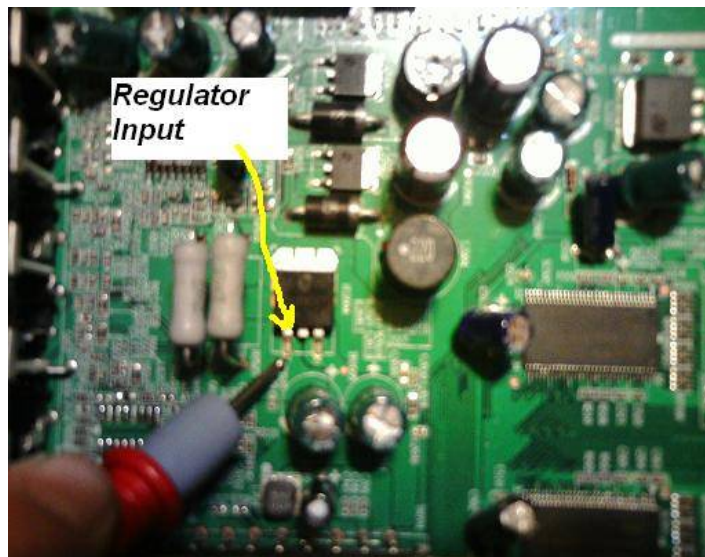

Checking Input Voltage to Regulator

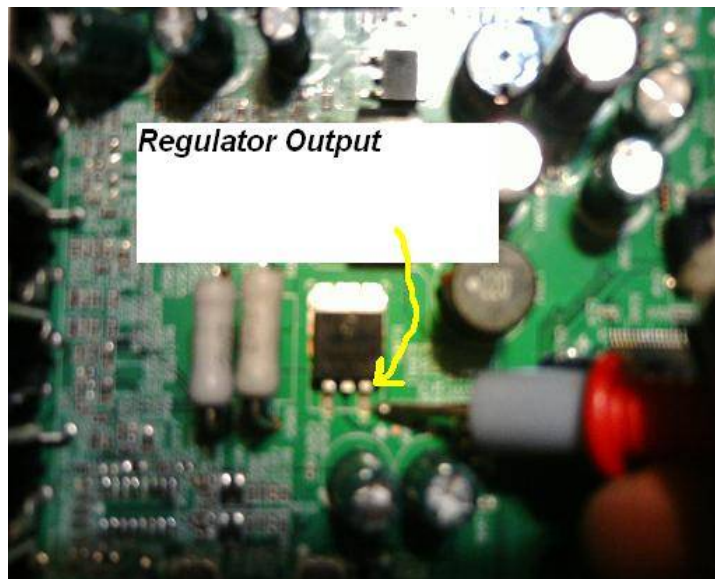

Checking Output Voltage From Regulator

Understanding and Testing Switches

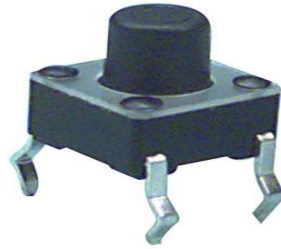

Typical Tactile Switch Found In LCD TVs

A switch is an electronic component which can break a circuit or divert current from one part of a circuit to another part. The most common type of switch you will see in LCD TVs is the tactile switch or “tact switch”. The common configuration is single pole single throw, normally open or “push to make” momentary contact.

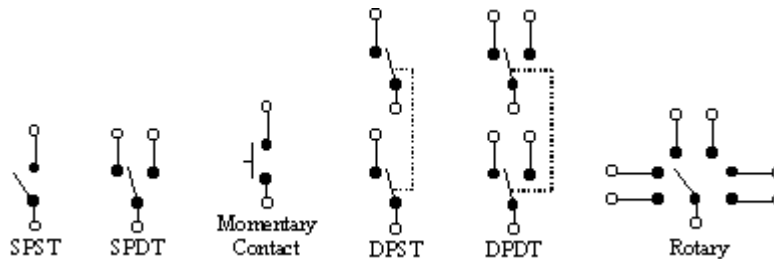

Switch Schematic Symbols

Testing Tactile Switches-

Testing tactile switches and any switch in general is very simple. Set your DMM to the continuity setting or your analogue meter to the x1 ohm range and place the test leads on to pins on opposite sides of the switch (polarity does not matter). You should get a reading of infinity. Now while still keeping the test leads on the pins, depress the button and the meter indicator should give a low or zero ohms reading and when you release the button the indicator should return to O.L. or infinity. Please note this is only for testing single pole single throw, normally open or “push to make” momentary contact switches, but I think you can see how easy it would be to test any switch with a continuity meter.

Understanding and Testing Fuses

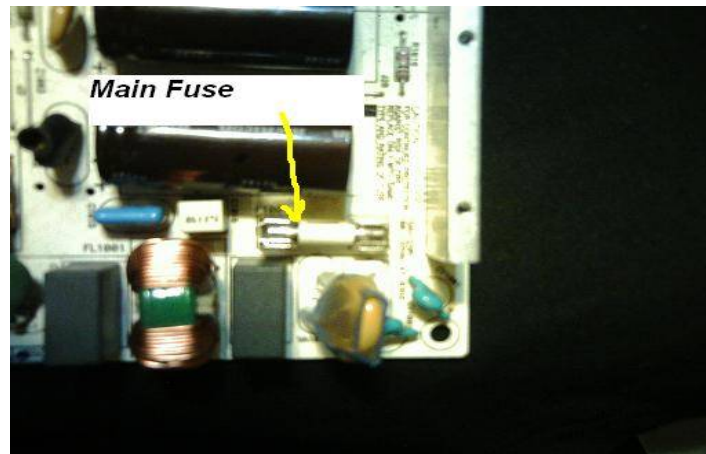

Fuse In LCD PSU

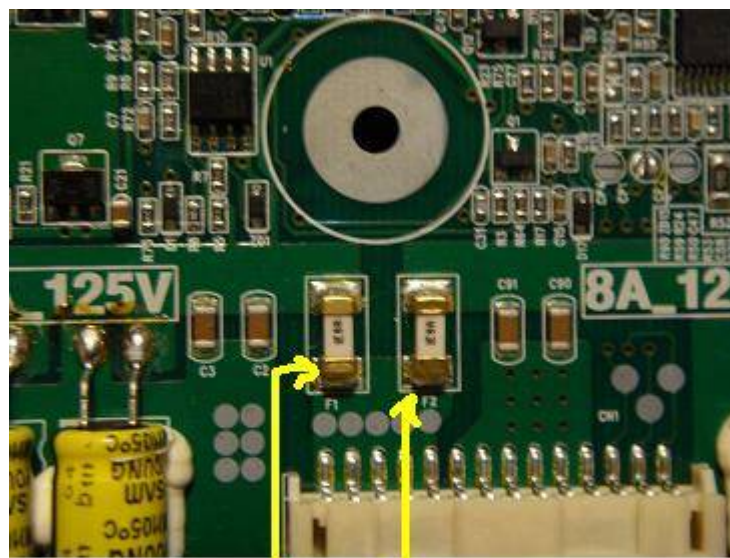

Pico Fuses

Pico Fuses On LCD TV Inverter Board

A fuse is an electronic component that is used as a sacrificial device for over current protection. It contains a wire or strip that melts when too much current flows through it, which interrupts the circuit that it is connected to. A fuse is destroyed by excessive current so that further damage or injury is prevented from overheating or fire. Always replace a fuse with the exact same value, type and rating as the one removed from the circuit.



Schematic Symbol For Fuse

Testing Fuses-

Set your DMM to continuity setting or your analogue meter to x1 ohm range. Place the test leads on the terminal caps or leads of the fuse (polarity does not matter), you should get a very, very low reading or zero ohms. This is the characteristic of a good fuse. A bad fuse will give a high, O.L. or infinite ohm reading. You can also normally visually inspect glass fuses and see they have blown, or the metal strip has just opened.

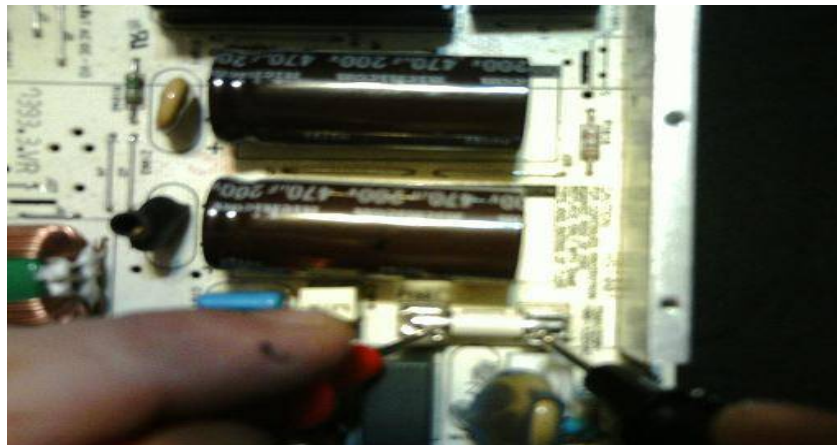

Testing A Fuse

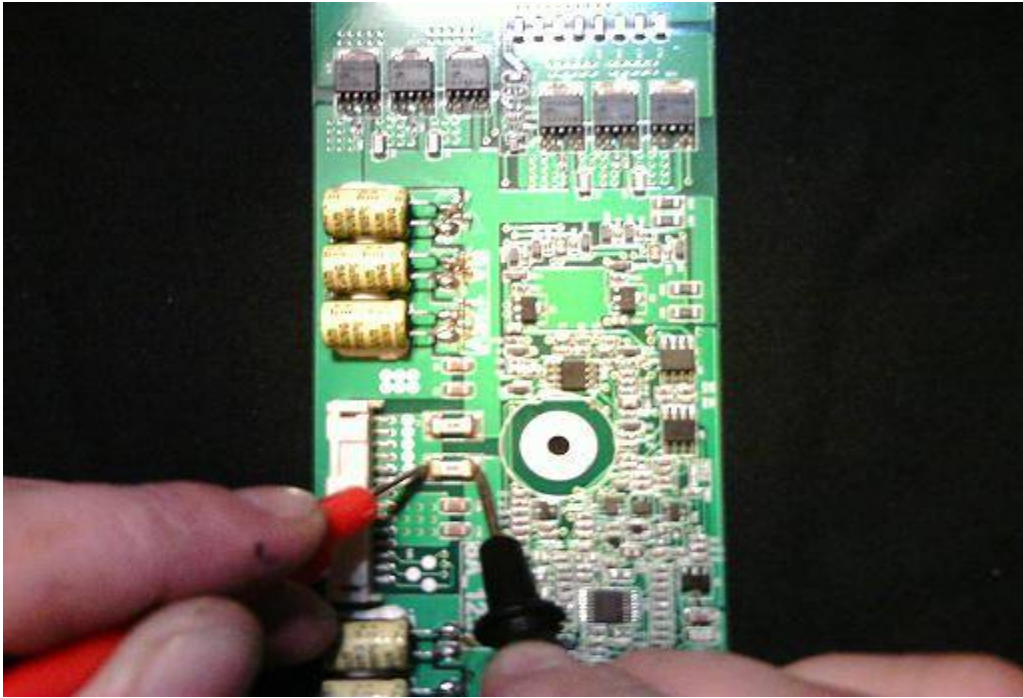

Testing A Pico Fuse

Some Testing Tips

-Always test components with a meter that is known to be good, with fresh batteries installed.

-I suggest removing components from the circuit before testing. Often surrounding components in the circuit cause erroneous readings to occur. At least lift/remove one lead from the circuit for most components.

-Learn how to test all electronic components and practice testing them so you can feel confident in yourself when testing components. Again I highly recommend the book "[Testing Electronic Components](#)", as I was not able to completely go over all the components found in electronic circuits and how to test them.

-Learn how to use your test equipment. Read the manuals and understand all the functions and settings. Your test equipment is your best friend when repairing LCD TVs. So the better you know how to use this equipment the faster and easier it will be to apply them to testing circuits and you may even develop some new testing methods yourself.

Useful Formulas

These are just examples of the basic and most commonly used formulas in electronics. You should know These by heart. There are many more that you should study and learn as well if you plan to further your understanding of electronics. These formulas are to be used for DC circuits or resonant AC(Meaning voltage and current are in phase and that the circuit Impedance is equal to the circuit resistance) circuit calculations.

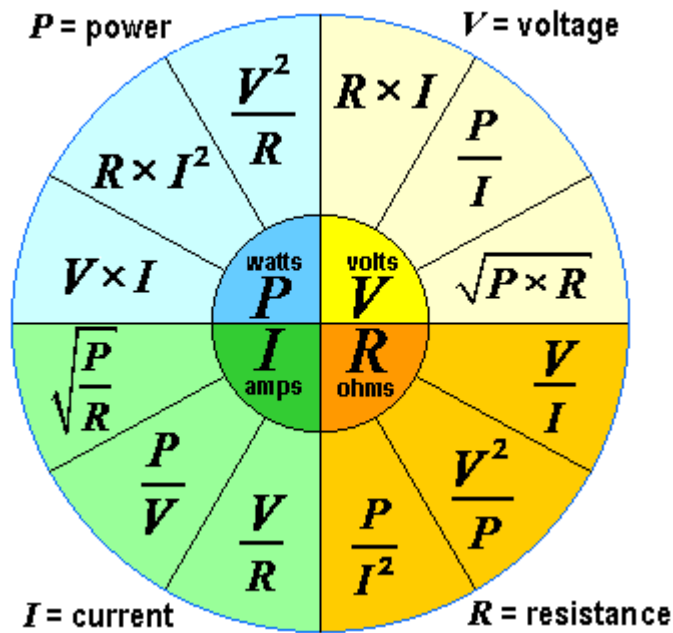

How To Disassemble An LCD TV

First start by laying a thick soft blanket out on a table large enough to lay the face of the LCD TV on.



Lay The LCD TV On Its Face

Next remove all the screws from the stand and remove the stand. Next remove all the screws from the back of the TV, it help to have a cup to keep all the screws in.

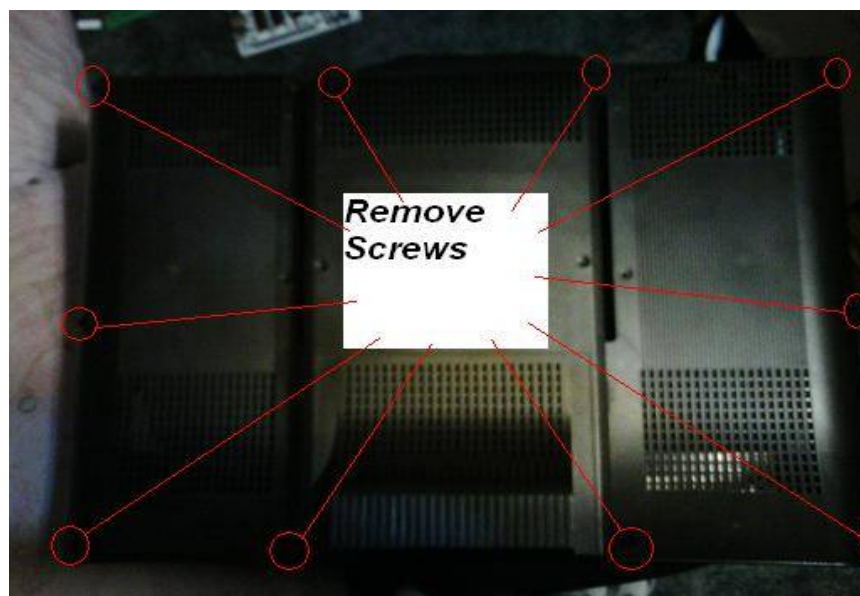

Remove the back and set it aside. Now you will have full access to the PCBs(Printed Circuit Board). To remove a PCB for component testing or for replacement, simply disconnect any cables going to the board from their connectors. Label them if necessary.

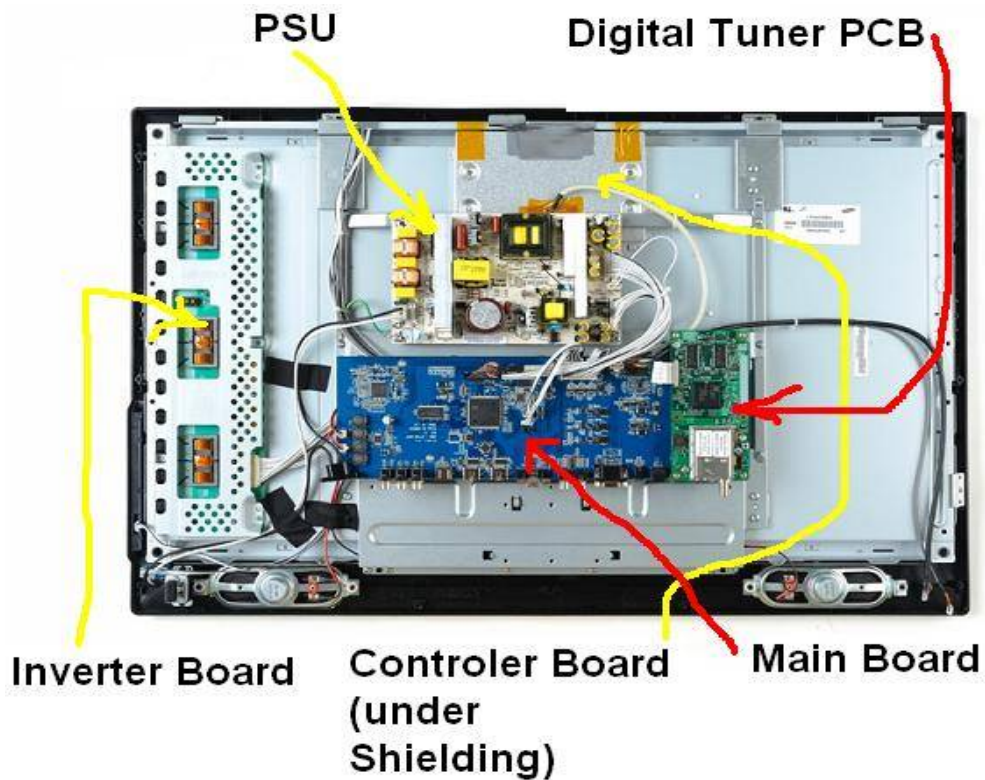

Exposed PCBs

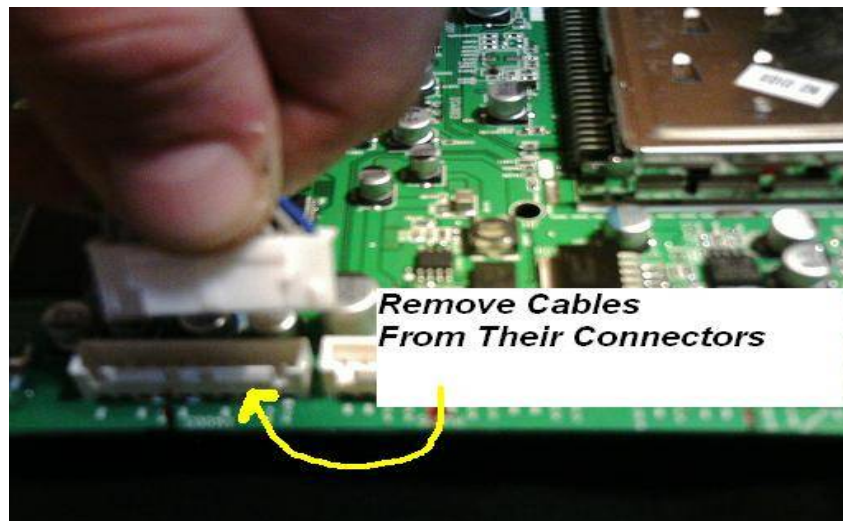

Next remove all the screws that hold the PCB to the TV. The board should now come loose. You may now test or replace components on the board you removed(remember if you remove the PSU the first thing you need to do is to discharge the reservoir or primary side filter capacitor).

Voltage Test Points

Warning!!!

Be careful when taking voltage measurements. Always use an isolation transformer. Remember when taking measurements on the primary/hot side of the SMPS use the corresponding primary side ground (hot ground) and when taking measurements on the secondary/cold side use the secondary (cold ground).



Isolation Transformer

Bridge Rectifier-

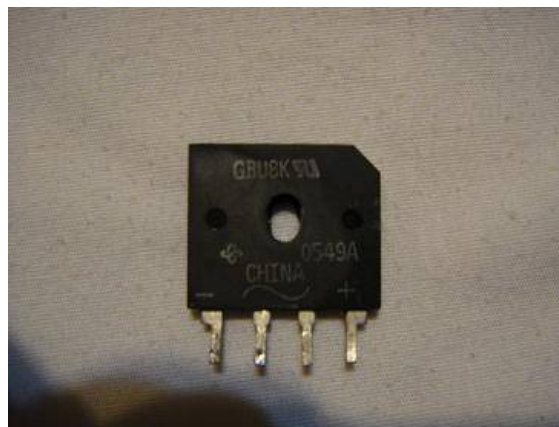

Plug the LCD TV in and locate the AC pins of the bridge rectifier marked by a wavy line (this is the AC symbol). Set your DMM or analogue meter to the proper AC voltage setting. Now place your test leads against the AC pins of the bridge rectifier. Hold them tightly and carefully in position be sure not to slip and short anything with your test leads.

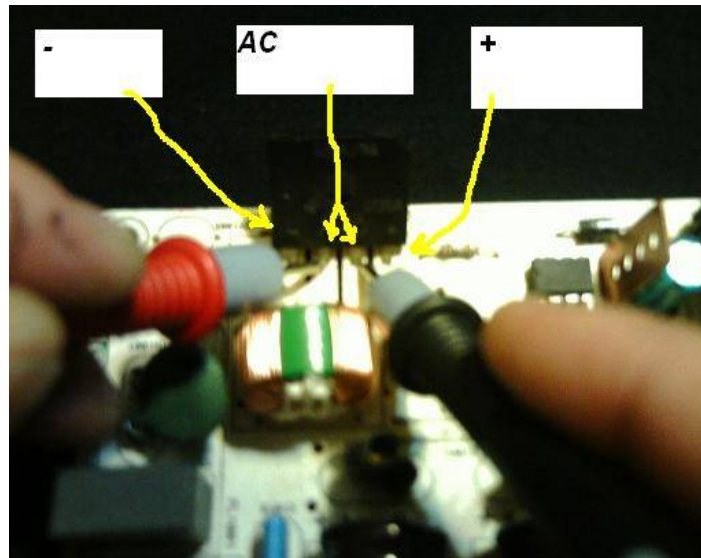

Placing Test Leads on AC Pins Of Bridge Rectifier

You should get a reading of around 110-120 volts AC (USA, in some other countries the voltage may be different find out the mains in your country and this is what you should expect) If you get zero volts then check in the circuits before the bridge rectifier, could be bad components in the EMI circuit, Blown main fuse, bad AC cord, electrical receptacle has no power, bad components in passive PFC circuit if TV uses this type of PFC, bad solder connection in circuits before or at bridge rectifier etc.

Reservoir Capacitor/Primary Filter Capacitor-

Once we have confirmed that the bridge rectifier is receiving an AC input at the proper voltage we can now expect to find a DC voltage at the pins of the reservoir/primary filter capacitor. Make sure the TV is plugged in. Now set your DMM or analogue meter to the proper DC voltage setting place your black test lead to the negative pin of the reservoir capacitor, next place the red test lead on the positive pin of the reservoir capacitor. Be extremely careful not to accidentally slip and short the pins of the capacitor together.

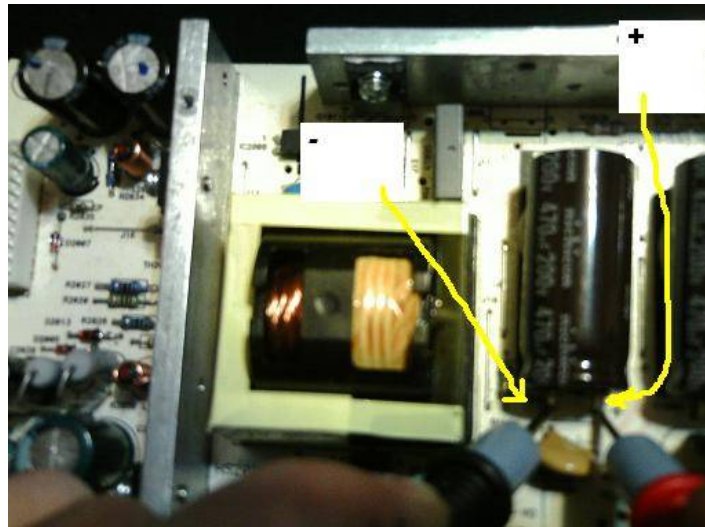

Testing Voltage At The Reservoir/Primary Filter Capacitor

You should get a reading of about 150-160V DC(USA, If active PFC is used expect 350-400V).

If you get the right reading then move on to the next voltage test. If you get zero or very low voltage check the surrounding circuits components, look for bad solder connections cracks in the copper trace, unplug TV then remove and test the bridge rectifier etc.

Power IC-

First you must look up the part number of the power IC you will be testing the positive supply voltage pin of. Once you locate the positive supply voltage pin of your power IC, set your DMM or analogue meter to the proper DC voltage range. Place the red test lead to the positive voltage supply(Vcc) pin and the black test lead to hot ground(reservoir capacitor negative pin). Remember the TV needs to be plugged in. You should get a reading that corresponds to the proper voltage for the power IC normally between 16-20V DC. If you get the correct reading you can assume all components up to this point must be good(bridge rectifier, fuse, EMI Filter circuitry, start up circuit, etc.). If you can't find the necessary information for you IC you can always skip to the next voltage test for this same reason. If the reading is low or zero volts the most common reason is that the start up resistor/s have changed value or opened. To find the start up resistor/s(start up circuit), trace back from the positive voltage supply pin to the large value resistor/s that bring the

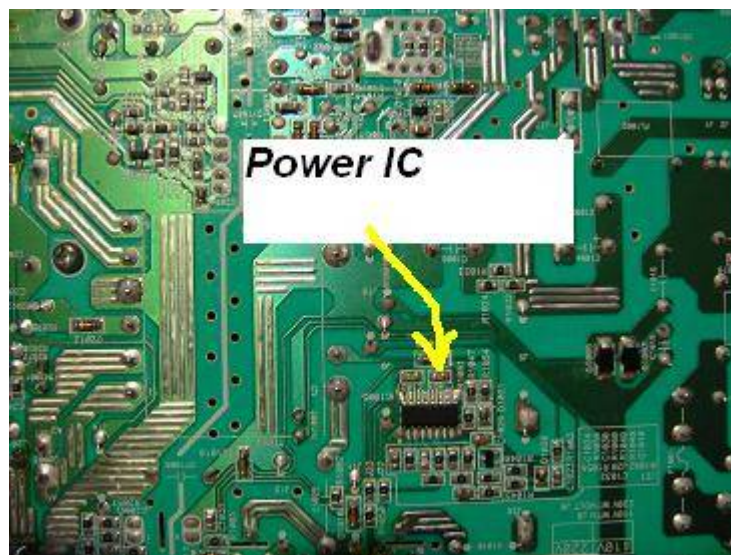

SMD Type Power IC/Half Bridge Driver

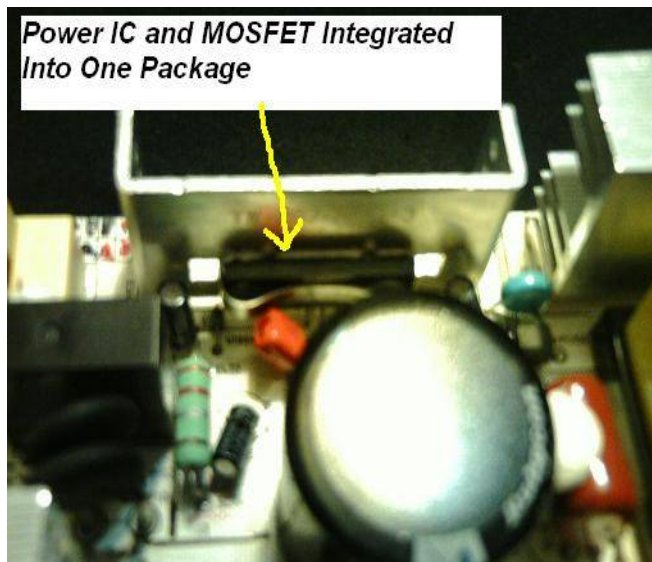

Power IC And MOSFET In A Single Package

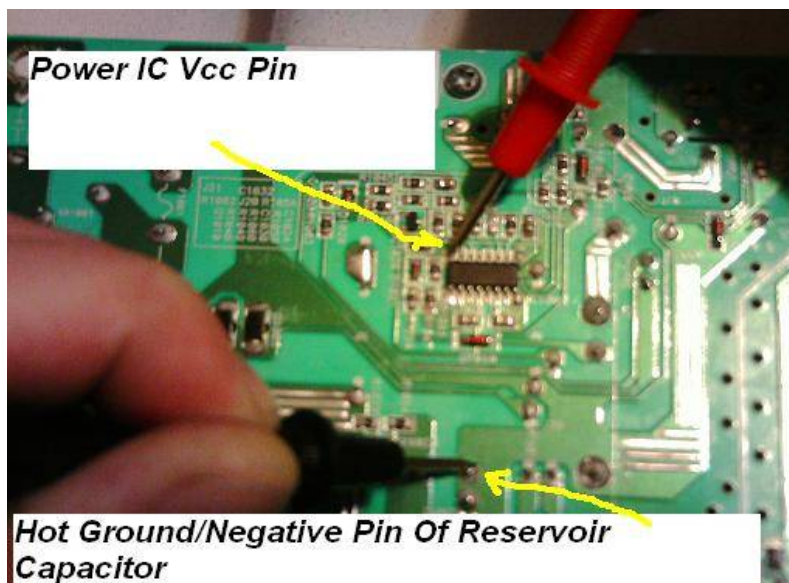

Testing Positive Supply Voltage Pin Of Power IC

voltage from the positive pin of reservoir capacitor to the Vcc pin of the power IC so that it can get power before the SMPS is on, once the TV is on a secondary winding on the SMPS switching transformer in the primary side supplies voltage to the power IC, this winding and a few other components like a resistor and a diode that rectifies the output from the secondary winding make up the run DC circuit. Some Start up circuits will grab voltage directly from the AC line and not the reservoir capacitors positive pin in which case you will also find a rectifier diode in the start up circuit that should also be checked.

Testing Secondary Voltages-

This is a very simple test for sure. Place your red test lead from your DMM or analogue meter on the cathode side of the secondary output diode you want to check and place your black test lead on cold ground. Make sure your meter is set to the proper DC voltage setting (most LCD TVs have secondary voltages of 5V, 12V and 24V but they can be more or different ones, if possible refer to the service manual of the TV you are testing). Turn power on to TV. You should receive a DC voltage that corresponds to the voltage you expect at that diode. You may have to look at a schematic or trace back from a labeled cable connector to know what voltage to expect. If you get a good reading on all secondary diodes, then you can assume that all the components on the primary side are working properly and checking components in the primary side of the SMPS would just waste your time most

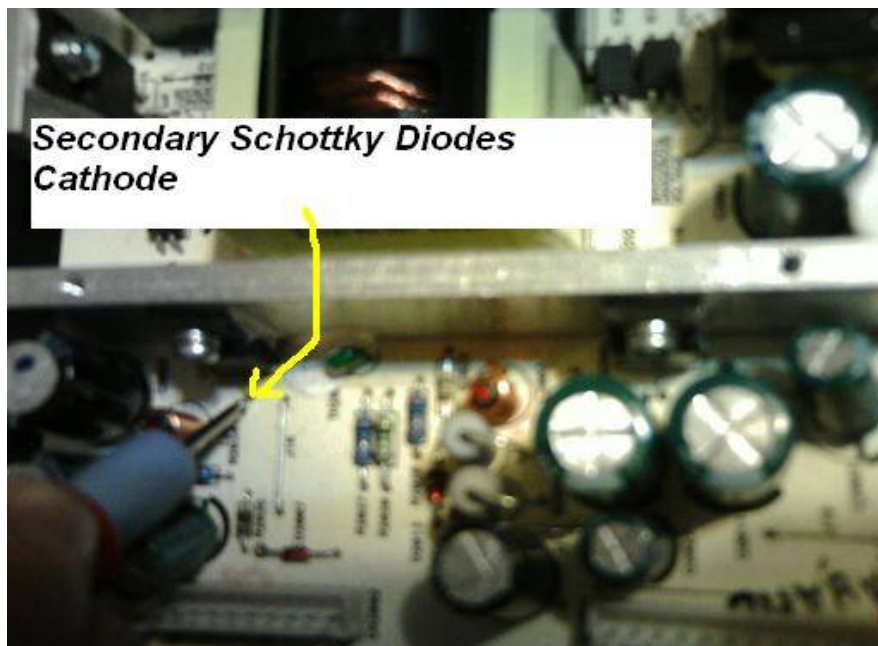

Checking Secondary Voltage

likely. As it is obvious if the bridge rectifier, power IC, power MOSFET and etc. were bad we would not get all of our secondary voltages.

Main Board Voltages-

If all of your voltage were good in the previous test next you should check that voltage is coming to the main board. If it is low or not present you know it must be something between the main board and the SMPS after the secondary diode, perhaps a bad filter capacitor, shorted components or maybe even a bad ribbon cable or bad solder connections etc. If the voltage is present to the main board then you can next check the voltage at the output of the voltage regulators that will be found on the main board typically 5V and 3.3V (and others, it depends on the TV) linear regulators. If the outputs are correct you can then move on to test the Positive supply voltage at each of the ICs on the main board. You may need a schematic or service manual which can usually be found online, to get the pin layout and Vcc voltage for each IC.

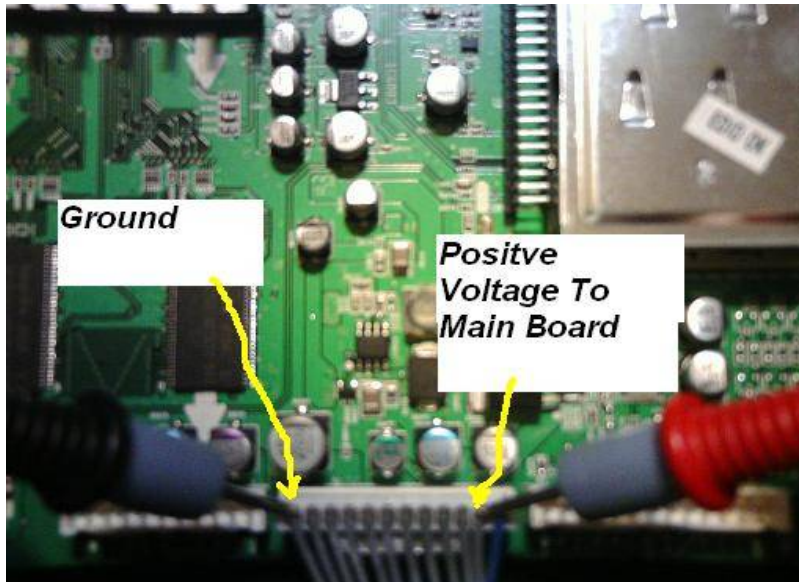

Checking For Voltage To Main Board



Checking Vcc Voltage OF LVDS IC



Checking Positive Supply Voltage Pin Of A NAND Memory IC

(Please use a very fine test lead when checking Vcc/Vdd of SMD ICs as the pins are very close together)

T-con Board Voltage-

With your DMM set to the proper voltage setting, place your black test lead to cold ground and your red test lead to the lead of the pico fuse closest to the cable that brings the voltage to the board, then check with the red test lead to the other lead of the pico fuse (terminal caps if SMD). You should get about 12V DC for both readings. If you only get one reading (on the side closest to the connector) the fuse has most likely gone open, try replacing it. If you get no reading on either lead, trace back and check all the components in the circuit that supply the voltage to the T-con board.

The Tap Test



This is an old test that is crude and simple, but it does work. Use this test to isolate connection problems or intermittent failures caused by bad solder connections etc. Using the back of your screwdriver or some slightly heavy non conductive tool, lightly tap around on the circuits careful to not damage any components or bend leads and cause shorts. The idea is to find the most sensitive part of the circuit that responds to your tapping causing the TV to go in and out of failure. When you find this sensitive area or maybe the only area where you get a reaction, inspect all the components for any damage and then look over all the solder connections carefully with a magnifier and light or a lit opti-visor. Look for cold solder joints, ring cracks or any solder joints that are questionable. Mark every bad or questionable solder connection you see with a marker. After you are done marking every solder connection go back with your soldering iron and some quality solder and re-solder all the marked connections.

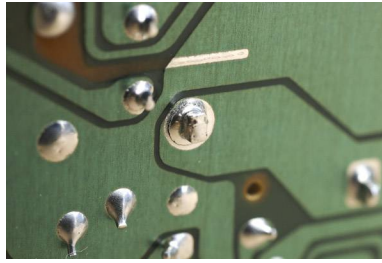

Ring Crack

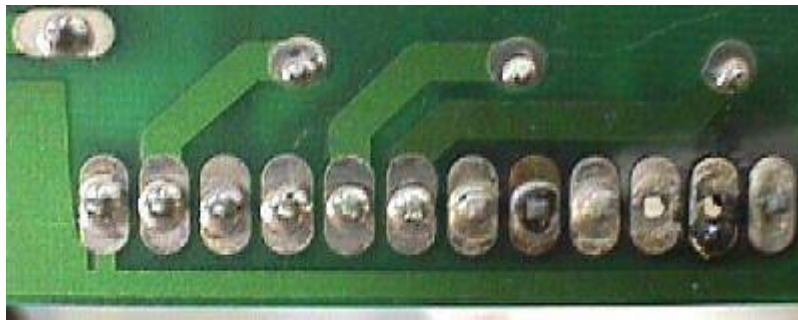

Cold Solder Joints And Some Ring Cracks

You may also find that the connections are all good, but when you tap right on a component the TV fails. You should directly replace the component if possible.

Freeze Spray and Hair Dryers



This is another test which will help you isolate a problem to a single area of the LCD TV. You may run into TVs that will not run properly until sometime after the TV has been turned on and warmed up. You may also come across LCD TVs that runs fine until some time after being turned on and then after warming up has a failure, maybe shutting down, distorted video, distorted audio etc. In the case that you have a TV that has a failure from start up which goes away after warming up you can try the hair dryer method. Let the TV set set for awhile so it is cool. Then turn the TV on and verify it is having the known failure. Then take the hair dryer and heat up the circuits with a smooth even action and carefully and slowly panning across them until you find a location that gives you a reaction. If you heat that area the TV starts to function properly. Once you have isolated the problem to any area recheck(by starting the test from cold again) to make sure, once verified check all the components in the isolated area.

If you can not find any bad components or connections you may want to directly replace components in this area if you have the parts. Now if you have a TV that falls into the other category. Working fine at start up and then failing after warming up then you will use the freeze spray. Turn

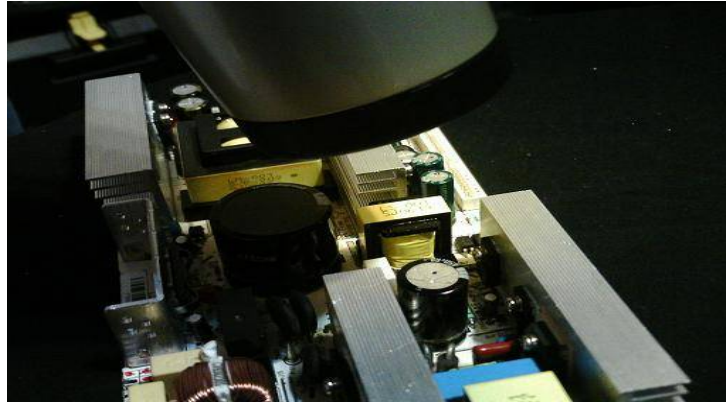

Using Hair Dryer

on the TV and let it warm up and stop operating normally, once this happens power off and unplug the TV use the freeze spray to cool down a section of one of the PCBs and components in the TV carefully going over all that section (but do it quick), after thoroughly cooling quickly plug in and turn on the set and see if failure is gone, meaning that an area you cooled down caused the TV to start functioning properly again if not, try again with another section, remember you have to be quick enough to make sure the TV circuits in general don't all cool down causing the TV to work normally as well. You need to make sure it is when you spray the freeze spray on that area that the TV is made to start working meaning you have isolated the problem. The small nozzle of the cool spray allows you to more precisely cool a small location unlike the hair dryer that's more wide spread when it heats, this will allow you to isolate the problem to a smaller area of a circuit and maybe even a single component. Once the problem is isolated carry on as you did previously in the hair dryer example.

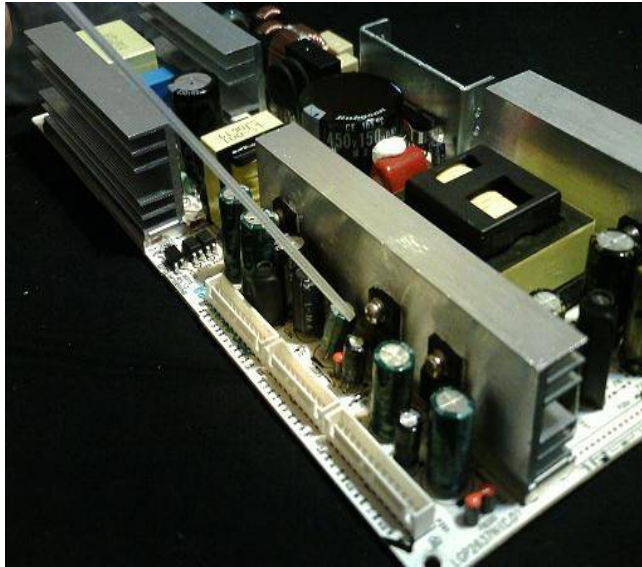

Using Cool Spray

Connection Problems

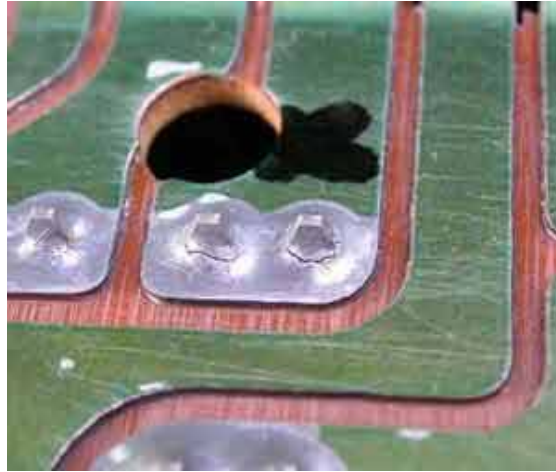

Solder Cracks



Loose Cables

Connection problems, we discussed some of them earlier in the book, can cause a lot of problems and you will find they are the reason for a good number of failed TVs. Most commonly you will find ring cracks and cold solder connection and even totally burnt up connections when inspecting PCBs with a magnifier or an opti-visor. Sometimes you will also find cables that have slightly crept out of their corresponding connectors causing a connection problem.

Connection problems will often cause intermittent issues but not always when they are really bad effectively causing a part to be removed from circuit or causing an open circuit in which case they will cause constant issues. Connection problems are so common in LCD TVs the first thing you may want to do is open the TV, inspect all solder connections on each PCB and re solder all questionable ones and bad ones. Re-seat all the cables into their corresponding connectors, careful not to bend or break any pins on the cable connector.



Inspecting PCB For Bad Solder Connections

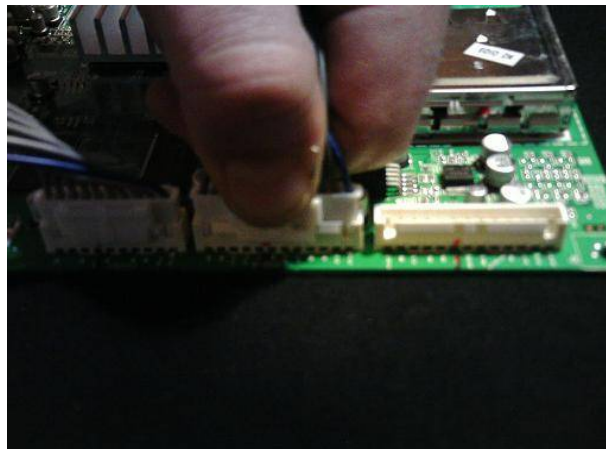

Re seating Cable To Its Connector 1

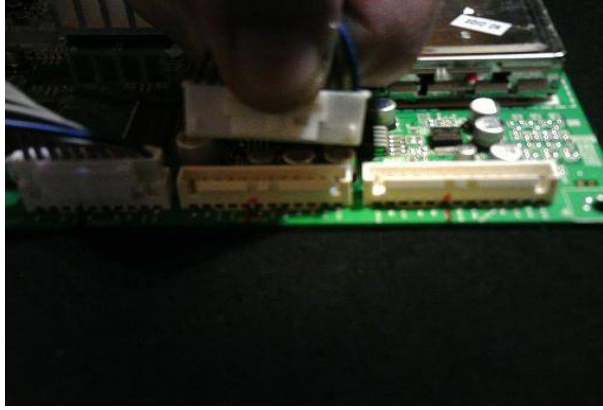

Re seating Cable To Its Connector 2

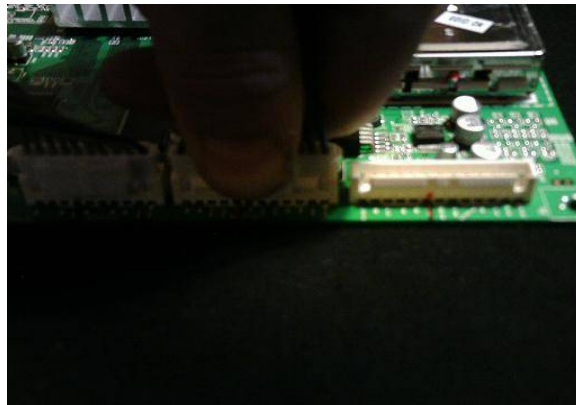

Re seating Cable To Its Connector 3

Once finished double check and make sure everything is properly reassembled and turn the TV on to see if the problem still persists.

PSU (Power Supply Unit) Failures

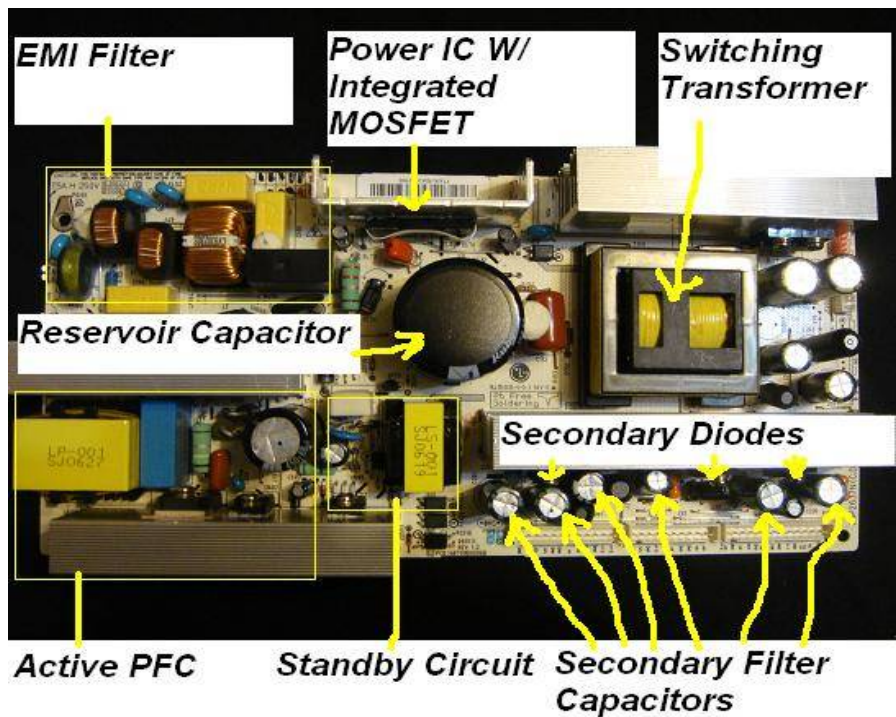
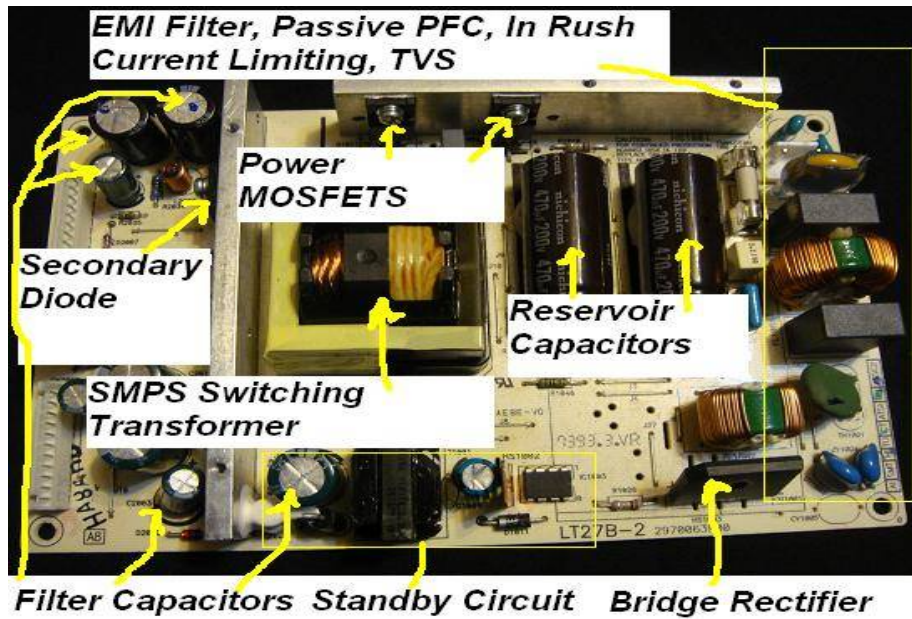

Now we will go over some common LCD TV PSU failures. PSU failure is quite common in LCD TVs, so I suggest you study as much as you can about SMPS and SMPS troubleshooting, as these are the types of PSUs used in LCD TVs. We can't cover everything in this book but we will cover the most common failures.

-TV is dead, Power/standby LED not lit and main fuse is blown.

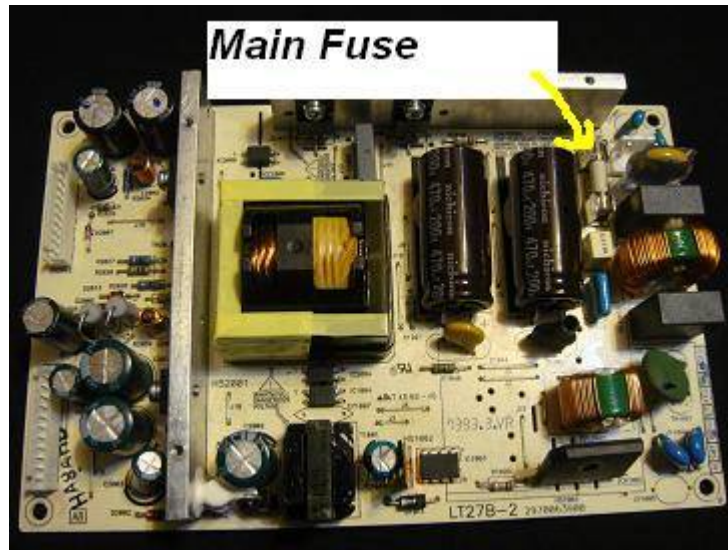

Check the bridge rectifier, diodes in primary and secondary side, reservoir capacitor(check for short and leakage), varistor(check for visible damage and or low ohm reading), Check power MOSFETS, Switching transformer etc. I you find lot's of shorted components in the primary side, replace the power IC along with replacing all the bad components as it will often have been destroyed as well

-TV is dead, Power/standby LED not lit and Main fuse is not blown.

Check the standby power circuit check the voltage at the secondary diode (typically 5V DC) cathode if not present or within tolerance check corresponding components. Check the secondary diode, filter capacitor and choke of the standby circuit. I have dead LCD TVs with a shorted standby circuit secondary diode and LCD TVs that were dead but the standby LED would flicker with bad secondary filter capacitors in the standby circuit causing the failure. Note that a blinking LED can indicate a failure code from the MCU, and the failure may not even be related to the power supply. If you get a pulsing LED that seems rhythmic or in a pattern (like 3 flashes pause two flashes repeat, etc.) refer to the service manual to see if the TV has LED codes or not and if so what they are as they can lead you to the right circuit for repair.

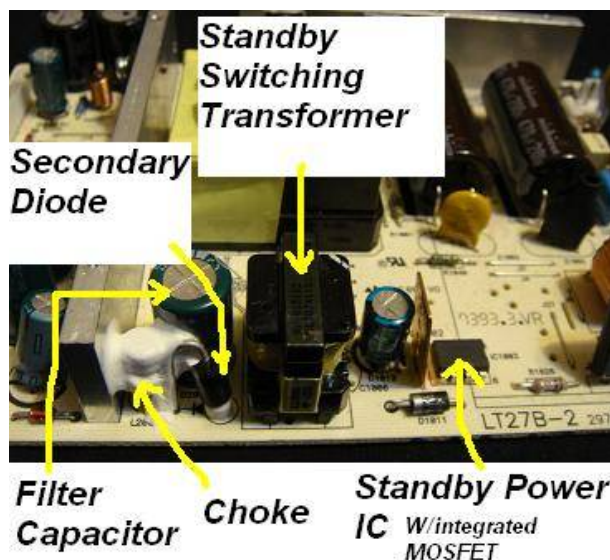

-TV is dead, Power/standby LED is lit and fuse is not blown.

Check for Vcc voltage to the power IC. If not present check start up resistors in the start up circuit.

-Start up circuit

The start up circuit usually consists of one or more large value resistors that drop the voltage from the 150-160V source at the positive pin of the reservoir capacitor to a voltage that is used to power the power IC when the SMPS is not on. The start up circuit may also grab voltage from the AC line in which case it will also have a rectifier diode.

Some more common failures.

-One or more secondary outputs with voltage out of tolerance or with ripple at mains frequency(50/60 Hz) or twice the mains frequency(100/120 Hz). Check the reservoir or main filter capacitor for high ESR. Also check surrounding components in the primary side.

-One or multiple secondary outputs with voltage out of tolerance and or ripple at the SMPS switching frequency(usually 10s to 100s of kHz). Check the secondary filter capacitors and chokes. Also if secondary voltage is low, check for shorted components in the circuit that could be dragging down the voltage.

-Whining noise coming from PSU with low voltage on one or more secondary outputs. Check for shorted semiconductors(diodes, BJT etc.) in the corresponding circuit.

-TV power supply making cycling/pulsing or chirping sound. This is almost always caused by shorted/failed components in the secondary side of the SMPS. Check secondary diodes, secondary filter capacitors, also check the feedback circuitry, meaning check the opto-isolators, directly replace the adjustable shunt regulator, check the resistors in the sampling circuitry etc.

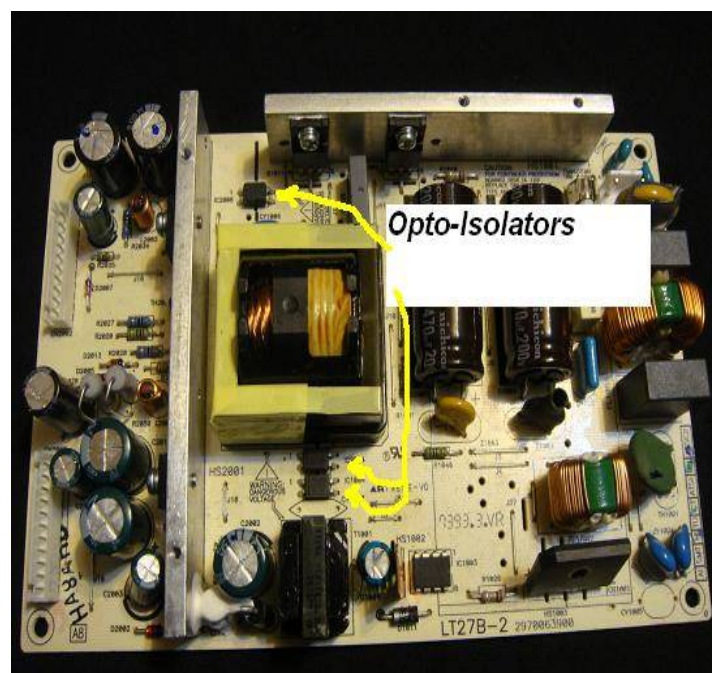

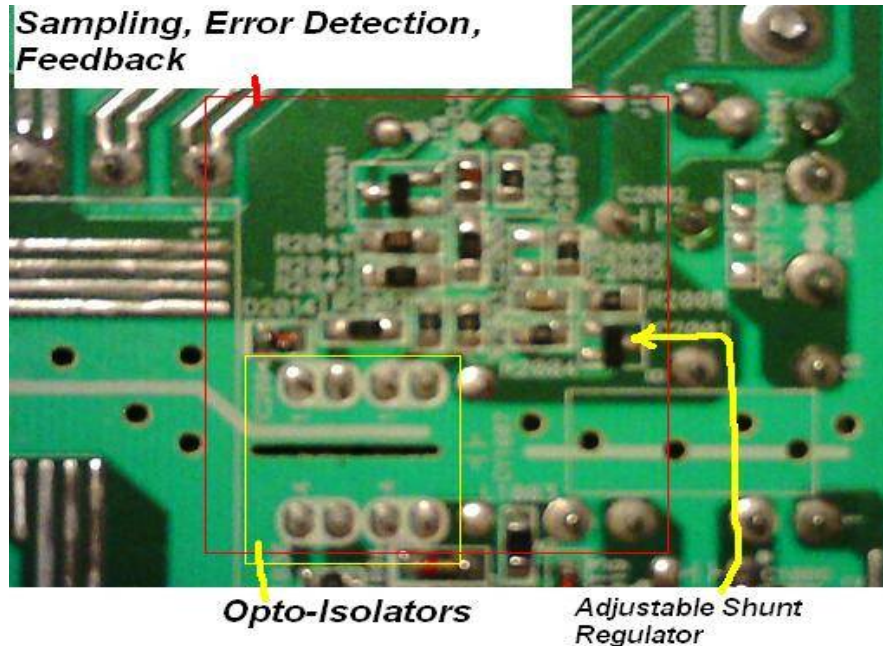

A bad power IC can also sometimes cause the power cycling symptom. If you have tried and checked everything with no success, you might try directly replacing the power IC.

-Intermittent power failures. This can be a frustrating thing to troubleshoot. You will want to use the tap method discussed earlier in the book because most intermittent failures in general are caused by loose/dry, burnt or oxidized solder connections. If checking and re soldering all the connections does not work the next think I would do is check all the electrolytic capacitors in the PSU as they can also cause intermittent failures.

-Replacing a PSU over repairing it. Sometimes you will have a PSU board with such extensive damage, say from a power surge that you will really need to consider looking up the price for a new PCB online as it may not be worth your time to try and save one that needs so much work done, but if you are like me you are going to try to fix it anyways to gain skills and satisfaction in a repair.

Please note:

PSU board connection problems and especially filter capacitors with raised ESR are so common and cause so many different problems in LCD TVs that may not even appear to be PSU related that the first thing I do on all repairs is inspect the PSU and check every electrolytic capacitor on the board, If all is good I then do the same on the rest of the PCBs.

Inverter Board Failures

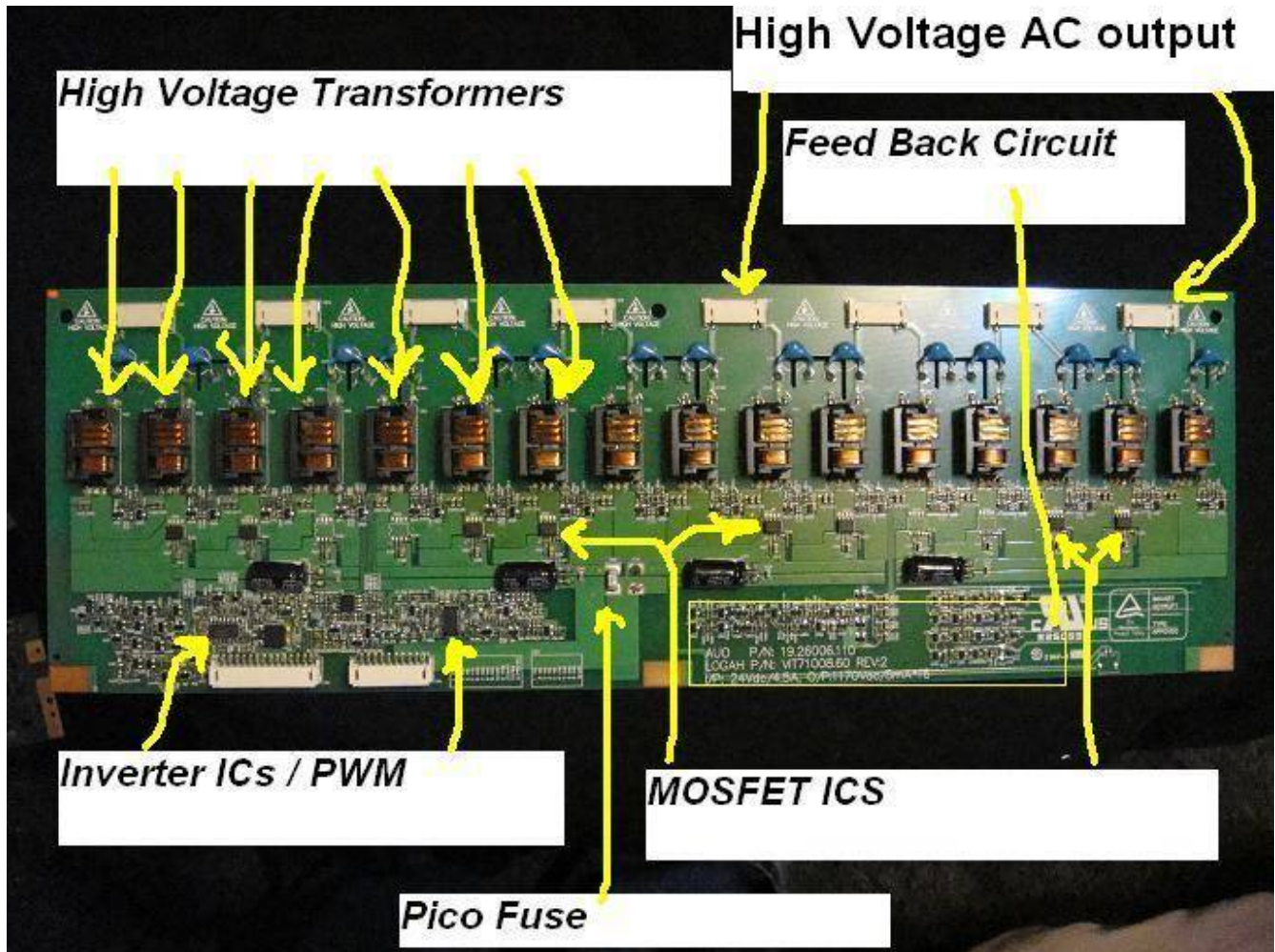

Most inverter board failures will cause one of these two symptoms. Either the TV will turn on but as soon as the back light turns on the TV shuts down (this can be very quick, the TV may just quickly flash and you must watch closely) or the TV will turn on and operate normally with audio but no picture. If you look carefully you can see that the picture is there but it has no back light to illuminate it. If you have one of these symptoms you will want to start by checking the inverter board (after checking the electrolytic capacitors in the PSU, they can also cause these same symptoms even a dim flickering display as well when the secondary filter capacitors on the voltage supply line to the inverter board go bad).

You may also have TVs with dim display or flickering display which is usually the inverter board also. Please note that these symptoms can also be caused by a bad CCFL

-Checking the inverter board

First thing, check the pico fuse/s usually found close to the cable connector that connects the cable coming from the PSU to the inverter board.

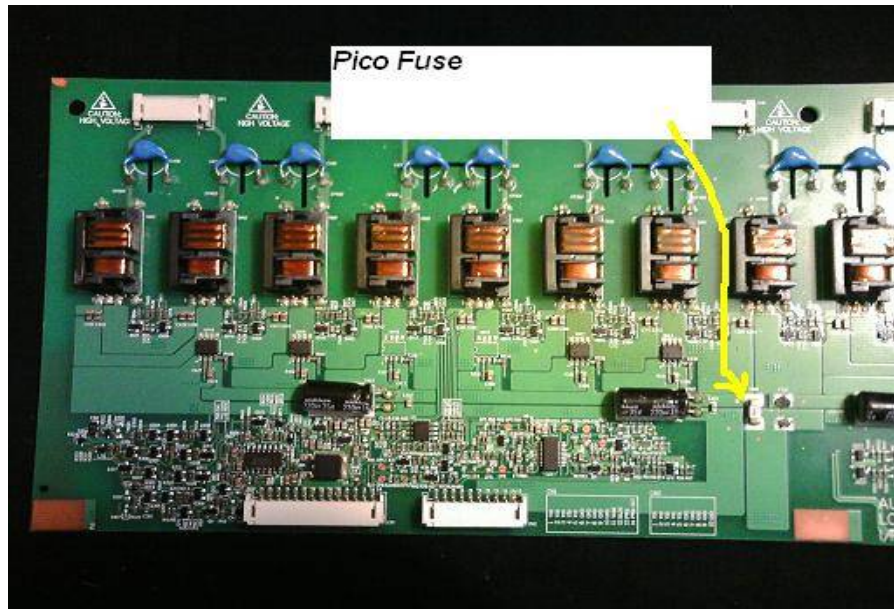

If the pico fuse or fuses are open or have a high ohm reading, first try replacing them and see if this fixes the problem (normally it won't) if it does not, move on to checking the components in the inverter circuits (if only one of two fuses is open check components in the circuit that correspond to that fuse). Inverter ICs are robust and don't fail too often. Suspect failed/shorted MOSFET ICs, HVT/s shorted between primary and secondary windings, shorted secondary or primary windings in HVT/s, compare results with known good HV transformer of same type, fortunately there are always more than one in LCD TV inverter boards so you can compare them against each other as most likely not all are bad (remember to pull them off the board to test and to identify the primary and secondary pins, they may not be the pins you assumed). Check resin coated ceramic capacitors in secondary are not shorted.

Check capacitors and other components in corresponding circuit. Use the ring tester on primary and secondary windings of HVT and like with the switching transformer in the SMPS if you get no rings try using the ESR meter.

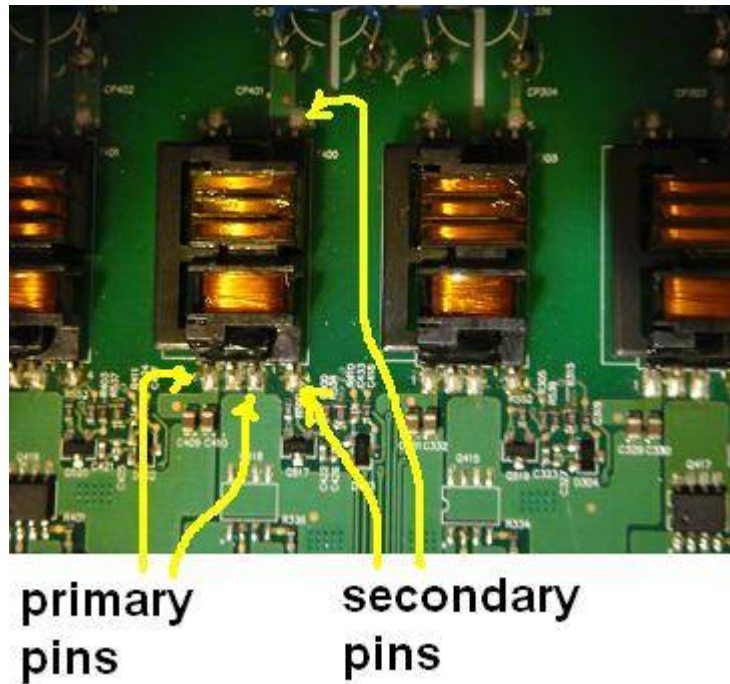

LCD TV HVT

-If fuses are not open on inverter board, check the HVT, check for open secondary winding, shorts in secondary and primary windings with ring tester. Remember that bad secondary filter capacitors in the circuit that supplies voltage to the inverter board can cause symptoms that are the same as a failed inverter board. Also check the components in the feed back/Over Load Protection circuit of the inverter board.

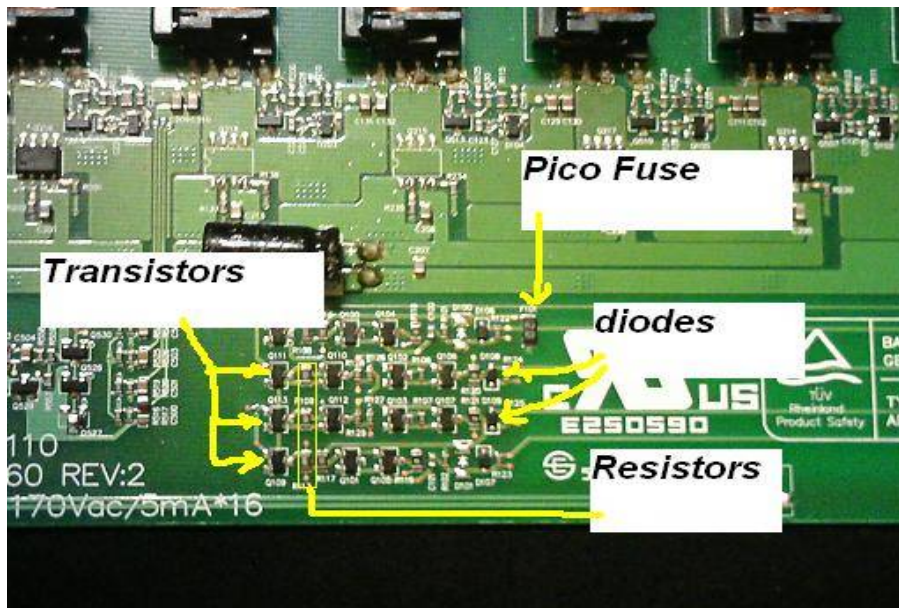

Inverter Board Feedback and Over Load Protection Circuit

If you can not find anything wrong with the inverter board it is likely you have one or more bad CCFL. You can use a CCFL tester for LCD TVs to find and then replace the bad CCFLs or you can directly replace all the CCFLs which wouldn't hurt since even ones that are not bad will likely be right behind the bad ones. Check the CCFLs for physical damage like blackened ends and for bad connections.



LCD TV CCFL tester

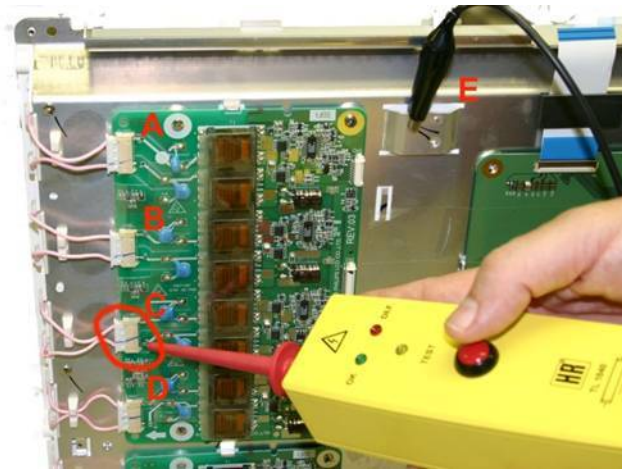

Using an LCD TV CCFL tester

Always check for loose or dry solder joints on the HVTs, MOSFET ICs and inverter IC pins. These are a very common cause of inverter failure. Sometimes you will not be able to find any good info for the parts on an inverter board or parts may not be available in which case you may want to just look into replacing the whole inverter board, usually they are not too expensive especially compared to replacing the TV. Also always save old inverter boards and all LCD TV boards for that matter so you can salvage parts from them that you may not have been able to acquire any other way.

Main Board Failures

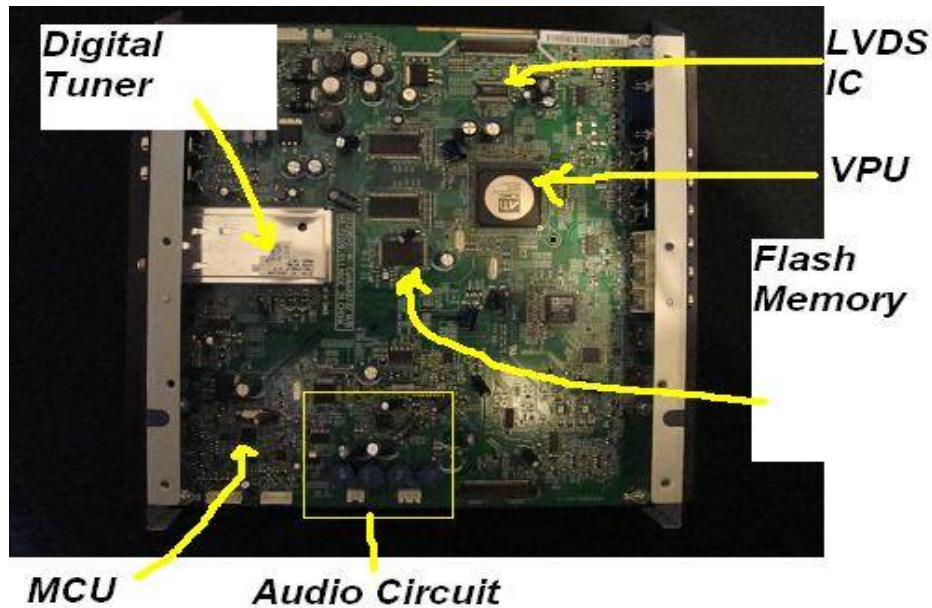

Common main board failures can include no video, no OSD(On Screen Display/Menu), no audio, tuning problems, video and audio distortions, no color, white screen etc. Main board failures can also cause no power and in this case will most likely have a symptom like blinking power/standby LED(often a code indicating the section/PCB of the TV that is failing), amber colored standby LED or some color other than normal standby or power etc. The PSU must get a start up signal from the MCU on the main board in order for the TV to turn on. If you are suspecting main board problem, first check for proper voltages to main board and ICs, you might need to get a schematic or service manual or study the board and look up the ICs online to get an idea of what the voltages you are looking for are, but typically you will have voltages like 5V, 3.3V, 1.8V, 12V and 2.8V DC. Remember to use cold ground when checking voltages on the main board. If all voltages are present and within tolerance remove the main board and inspect for bad solder connections and then check all the electrolytic capacitors like the decoupling capacitors found by each IC.

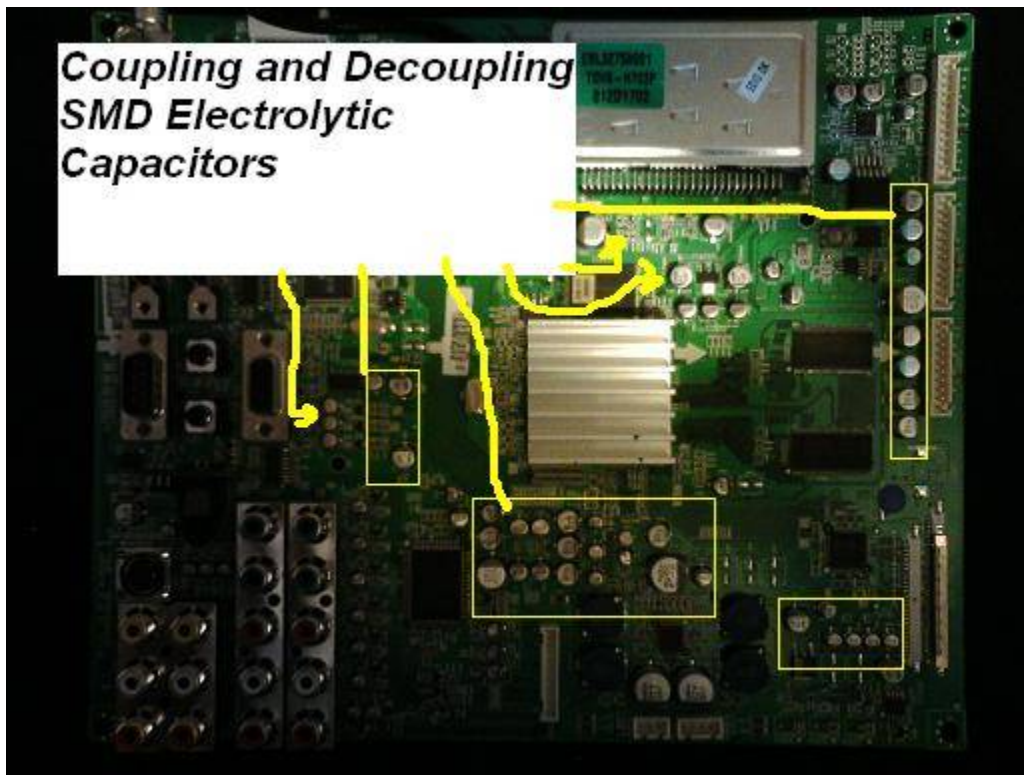

Check components surrounding ICs including crystals and SMD capacitors.





SMD Ceramic Chip Capacitors



SMD Electrolytic Capacitor

Crystal-

A crystal oscillator is an electronic circuit that uses the mechanical resonance of a vibrating crystal of piezoelectric material to create an electrical signal with a very precise frequency. This frequency is commonly used to keep track of time (as in quartz wristwatches), to provide a stable clock signal for digital integrated circuits, and to stabilize frequencies for radio transmitters and receivers. The most common type of piezoelectric resonator used is the quartz crystal, so oscillator circuits designed around them were called "crystal oscillators".

Quartz crystals are produced for frequencies from a few tens of kilohertz to tens of megahertz. Over two billion crystals are manufactured annually. Most are small devices for devices such as wristwatches, clocks, radios, computers, and cellphones. Quartz crystals are also found inside test and measurement equipment, such as counters, signal generators, and oscilloscopes.

Testing Crystals can be simple. Set your DMM to the frequency setting(if it has one, if not you can use a frequency counter) and place the red test lead on one of the crystals pins(TV Must be powered on), The frequency should be within tolerance of the frequency labeled on the crystal. You will not be able to test all crystals as some will be out of the range of your meter. Also take into account your meters accuracy. If you have a scope you can also use it to test crystals again if it's range is withing the frequency of the crystal you want to test.

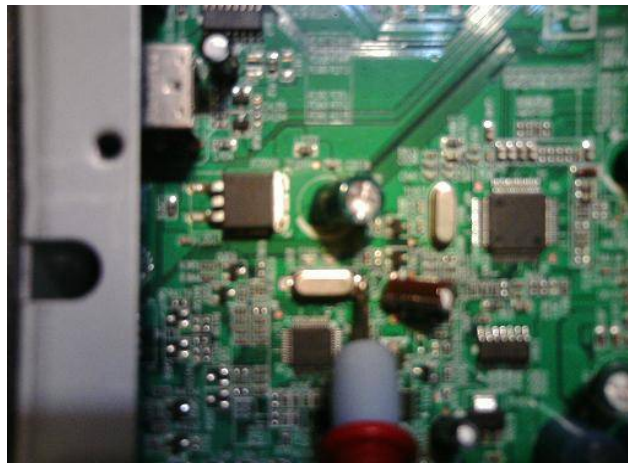

Testing SMD crystal with frequency setting of DMM

If you get no frequency reading this could indicate a bad crystal, SMD capacitor in the oscillator circuitry or a bad IC, check the surrounding components in other words SMD capacitors etc.. Try directly replacing the crystal. If the surrounding components test good and/or replacing the crystal does not work most likely the corresponding IC is bad, in this case the main board will most likely have to be replaced as replacement ICs can be hard to find and even if you could get them many are in BGA(Ball Grid Array) or other SMD package which require special equipment and or skill to replace.



Testing SMD capacitor on main board

Firmware upgrades-

Sometimes main board type failures can be solved by uploading the flash memories firmware, or reprogramming a corrupted flash with the original firmware. Firmware can normally be downloaded and put on a flash drive or memory stick to be put in the USB port or memory card reader of the LCD TV by visiting the manufacturers website or calling them and ordering it.



Sometimes you may need to purchase the firmware and in this case the company usually sends a thumb drive with the firmware on it.



Flash/Thumb Drive

No Video

If you have a TV that works fine but has no video(blue screen, white screen etc.), first check the obvious and make sure it is not a problem with the video source(DVD player cable box etc.) or a connection problem like a loose cable between the video source and the TV. After verifying that the source and connections to the TV are good we can move on. No video can be caused by an inverter board failure, but this is not common in LCD TVs, as usually the feedback circuitry for the TV will shut the TV down in the event of inverter board failure. Look closely at the TV if it is black but you can kind of see video when looking closely than this verifies that it most likely is the inverter board, but remember it could always be bad electrolytic capacitors on the PSU board. If you can tell that the back lights are lit and you have OSD(On Screen Display) but no video than you most likely have a tuning issue(like a failed digital tuner) with the main board or maybe something simple like your on the wrong input or a setting in menu for instance like needing to switch from antenna to cable. It could also be a bad VPU or other another IC on the main board, check all the main board and main board IC voltages and make sure they are within tolerance.. If you are using the co-axial connection on the tuner you may also have a bad tuner, verify by fist running through a different tuning source for instance a cable box or VCR first, then to the TV if this fixes the problem you know the tuner is bad and needs to be replaced. If you have checked the obvious like the menu setting then you should follow the procedure for checking the main board. Try a firmware upgrade, sometimes no video can also be caused by a bad controller board(not when OSD is visible). Check to see if the pico fuse on the controller board is open or has increased to high ohms value if so try to replace if replacing open fuse only causes fuse to blow again you can try fixing the controller board by tracing down shorted components with a tool like the leak seeker but your best bet would most likely be to replace the controller board. Don't forget to look for solder connection problems on the main board or jack pack when troubleshooting video and audio problems, especially right on the connectors that the video/audio source cables plug into. Often cracks develop in the solder connection because of cables being pushed in and pulled out of the video/cable cable connectors.



Checking controller board pico fuse

If the pico fuse is good and you have scope verify output signal from main board, if present and testing main board checked good check all components possible on controller board or directly replace, if controller board is found to be good, then the most likely case is the main board will need to be replaced if you can not find the bad components on the main board . Remember to check all the electrolytic capacitors on the main board, main board and IC voltages and IC surrounding components.

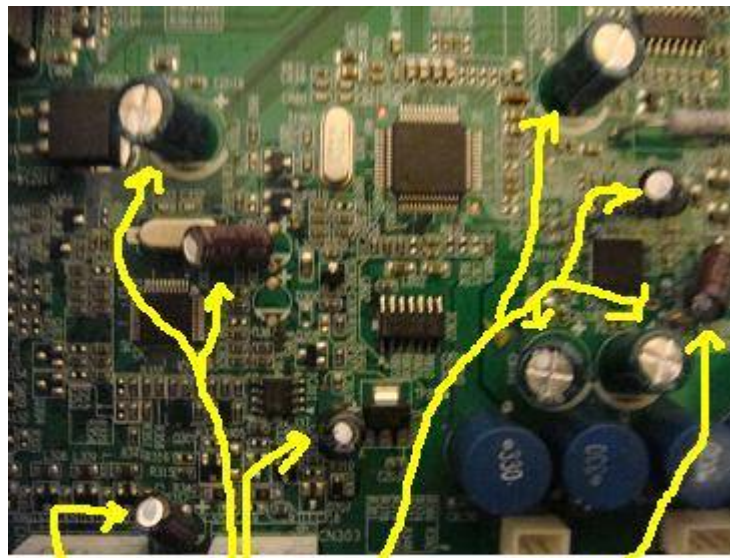

Electrolytic Capacitors

Electrolytic capacitors on LCD TV main board

No Audio

As usual check the obvious, like the connections from the audio source to the TV and check in the user settings within the menu to make sure the speakers are not turned off. Sometimes issues such as low audio while watching DTV but normal Audio during analogue programming etc. can be fixed with a firmware upgrade. Remember bad filter capacitors on the PSU as well as the main board can cause all kinds of problems like no audio or intermittent audio. Check the Vcc at the audio processor and the audio amplifier ICs, if no or low voltage is present lift the Vcc pin from circuit, if the voltage returns after removing the ICs pin suspect the IC is bad and replace, if voltage stays low or is not present after lifting pin suspect components in the voltage supply line to the IC.(remember to always check surrounding corresponding circuit components). Again don't forget to look for solder connection problems on the main board and or jack pack for video and audio problems, especially right on the connectors that the video/audio source cables plug into. Often cracks develop on the solder connections because of cables being repeatedly pushed in and pulled out of the video/cable connectors or because the cables get tugged on, tripped over or moved around to often.

OSD/Menu Failure

If you have no on screen display or no menu or erratic menu functions, you may also have menu functions but the user setting can not be saved, or reset every time the TV power is cycled. This indicates an MCU or VPU failure and or EEPROM failure and in most cases unless you have another main board to swap ICs from, and in the case of the VPU very specialized expensive equipment for testing removal and replacement, you will have to replace the main board. Remember to check all components surrounding the MCU and VPU like SMD capacitors, resistors, crystals etc. and also always check all the electrolytic capacitors on the main board.

White Screen



If the LCD TV powers on with an all white screen, first as usual inspect the PSU for bad solder connection and check all the electrolytic capacitors on the PSU. Next check the pico fuse on the controller/T-con board. Remember the controller board is ESD sensitive, so take the proper precautions when testing the board. Check the LVDS cable from the main board to the controller board and make sure it is not loose. Also check the solder connections on the cable connectors.



Cable from main board to controller board

Check and re seat the FPCB or ribbon cable from the controller board to the driver board.

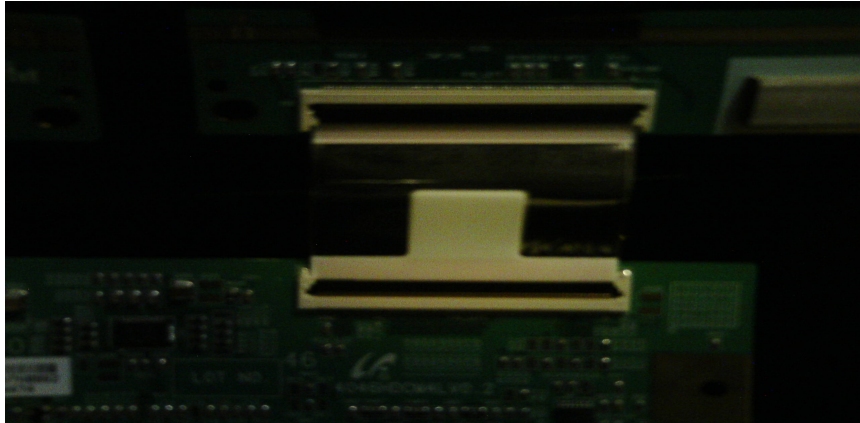

Ribbon cable connecting controller board to driver board

If all the previous checks out good then check the main board component like electrolytic capacitors etc.

If the pico fuse on the controller board is open or has become high ohm value, try replacing the fuse to see if it will fix the TV. If not you can replace the controller board or use a tool like the leak seeker to find the shorted components on the controller board. Usually with controller boards it is best to just replace the PCB. Sometimes it will be necessary to replace the main board or even the panel for white screen failure but most of the time white display is caused by a bad controller board or bad electrolytic capacitors in the PSU (Most likely secondary filter capacitors on the voltage line to the controller board).

Rainbow Screen

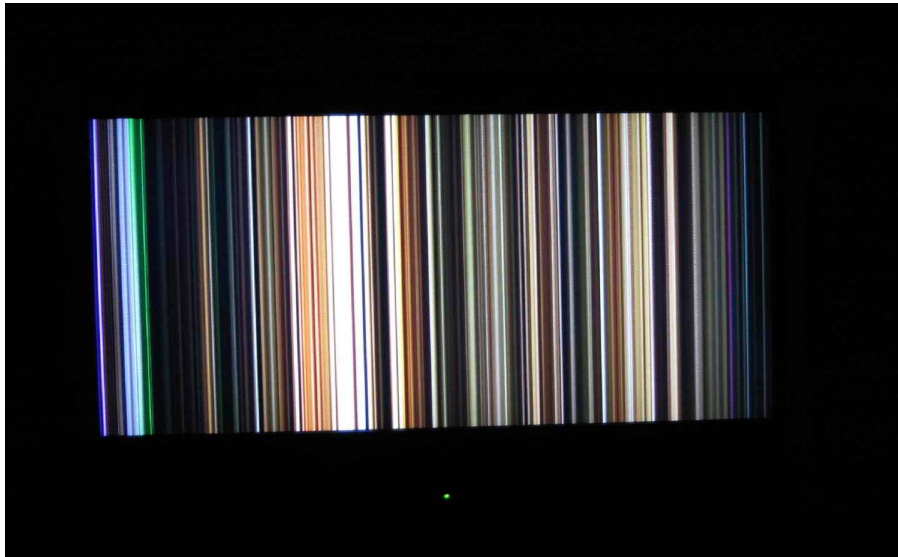

Steps for troubleshooting the rainbow screen or colored lines screen. First check the LVDS cable from main board to controller board is not loose. I check that the cable itself is actually good and re seat the LVDS cable, replace LVDS cable if necessary. Re seat FPCB from the controller board to the driver board and also check the solder connections on the cable connectors to the boards. Check solder connections and components on the controller PCB. If everything checks good, although this still could be a main board issue it is most likely a bad controller board IC or the panel. More likely the LCD panel has a bad driver board/driver ICs, but use the procedure for checking the main board before you spend the money to replace a panel if you actually decide to or if the cost is economical. Note that you can almost never find the LCD panel alone, but only a full display panel which has the back light assembly and all. Most people refer to this whole assembly as the LCD panel, but actually you can disassemble and remove the actual LCD panel like the photo on page 35. Together the LCD panel, and the back lights make the LCD display. Usually when you order a full display(listed as panel with part distributors) it will also have the controller PCB mounted to the back already but not always so ask, this can be good if you are not quite sure if the LCD panel or controller PCB are causing the issue.

Screen Flashes Then TV Shuts Down

If you turn on the LCD TV and it flashes, meaning that the back light comes on for just a moment and then the TV shuts down this almost always indicates an inverter board failure. Go over the methods for testing the inverter board. Remember bad secondary filter capacitors on the voltage supply line to the inverter board can also cause this symptom and also flickering or dim display.

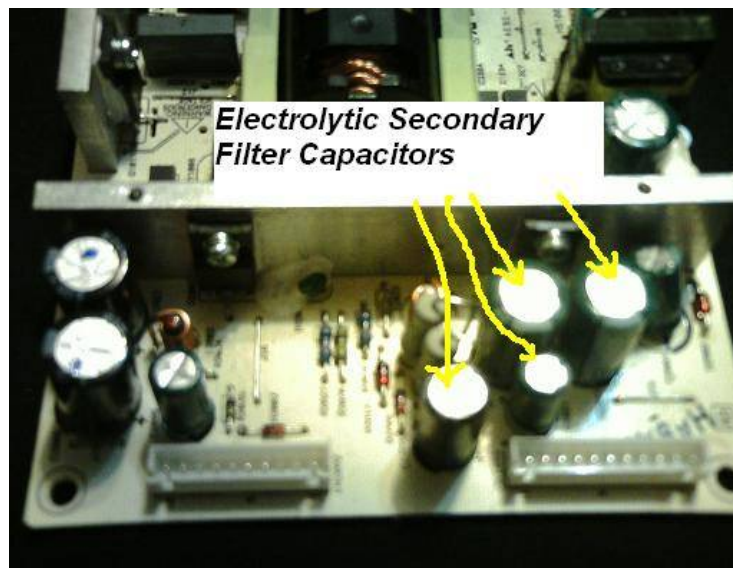

No Back light

This is when the LCD TV turns on and works normally has audio and if you look closely it has OSD, video etc., but the display is not illuminated. This is almost always an inverter board failure. Go over the procedure for troubleshooting the inverter board. As I have said many times now check the electrolytic in the PSU.

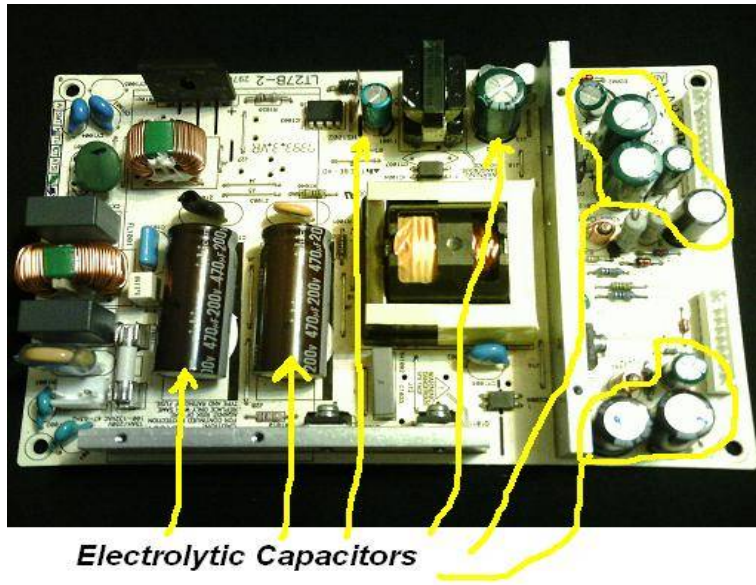

Lines In Picture

Vertical and horizontal lines as well on the display are almost always caused by bad connections from the driver board to the panel. In this case the display or panel must be replaced unless you have the specialized equipment necessary or can come up with a device to safely redo all the connections on the FPCB that connects the driver board to the panel and even if you could repair the connection there is still a chance you could have a bad driver IC in the FPCB.

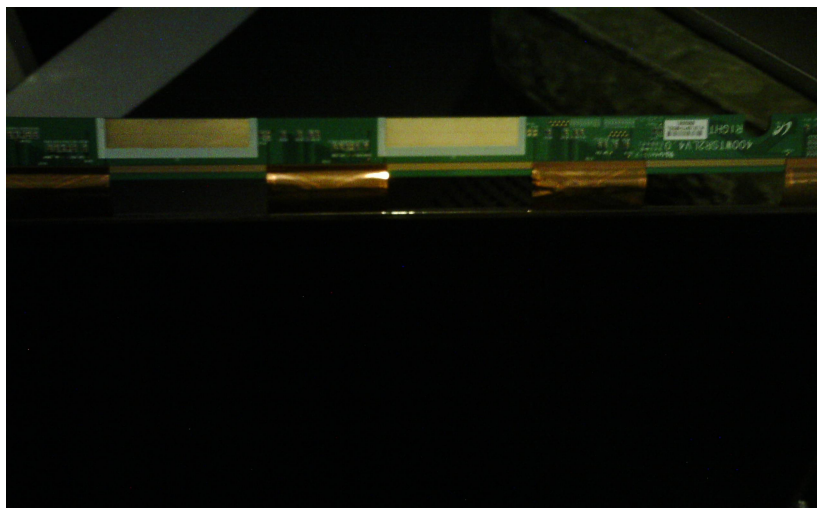

FPCB(Flexible Printed Circuit Board) that connects the driver board to the LCD display

Cracked panel



If the panel becomes cracked the only method of repair is to replace the diplay or remove the LCD panel from the display and replace it, but most likely you will have to buy an entire display, back light assembly and all.

LCD TV Repair Case Histories

Vizio L37HDTV-

Symptom:

Amber light , no power

Repair:

Removed U26 (this is near the tactile switch) and added a 10Kohm resistor between pins 2 and 3.

Vizio VO47LF-

Symptom:

Set has no back light, has audio.

Repair:

Replaced 2 680uF @35V Electrolytic capacitors on the inverter PCB, and one in PSU.

Samsung LNT4061FX/XAA-

Symptom:

TV had vertical colored lines no OSD and no remote function.

Repair:

Found 4 1000uF @16V electrolytic capacitors in power supply puffed and vented. ESR to high for meter to display reading. Part location numbers for capacitors, CM11 CM12 CM17 CM6. Replacing Capacitors fixed TV.

Samsung LNT4661F-

Symptom:

Takes a while to come on, when it is on, there are red dots over the video.

Repair:

Replaced three 1000uF @16V electrolytic capacitors in the PSU. Location CS804, CV812, CV813

Samsung LNT4671FX-

Symptom:

Unit cycles on/off for minutes before coming on.

Repair:

Replace electrolytic capacitors with locations, CM853 and CM852, both 2200uF @10V in PSU.

Westinghouse LTV32W1-

Symptom:

No power, power LED turns blue to amber then off , might be intermittent.

Repair:

Found bad solder connection on PSU transformer T1 pin 4, soldering connection fixed TV.

Sylvania LC320SL8-

Symptom:

Dead set, main fuse blown, and blows violently if replaced.

Repair:

1 1N5406 diode D502 shorted, Bridge rectifier shorted. Replacing shorted components and fuse repaired the TV.

Sharp LC37D43U-

Symptom:

No back light.

Repair:

Replaced fuse (F7502) rated 500ma on the inverter board. TV worked fine after replacing fuse.

Polaroid FLM323B-

Symptom:

No Audio.

Repair:

Replace open 10 ohm SMD resistor (R385) near the top end of the main board located between two audio supply filter caps.

Polaroid FLM3732-

Symptom:

No power, no standby LED

Repair:

Replaced 1000uF @10V electrolytic capacitors, locations C112 and C113 on the PSU.

Magnavox 19MF337B-

Symptom:

Flickering picture, loud audible noise, maybe be intermittent start.

Repair:

Replace electrolytic capacitors in PSU. Location C12, C117, C118(1000uF @16V) and C175(470uF@16v)

Magnavox 37MF321D37-

Symptom:

No power.

Repair:

Replace electrolytic capacitors in PSU (likely vented) two 2200uF @50V and two 1000uF @50V.

Magnavox 50MF231D/37-

Symptom:

Power LED lights but set does not come on.

Repair:

Replaced bad 3300uF @10V electrolytic capacitors, locations C8059 and C8060 in the PSU.

LG RM-30LZ50-

Symptom:

Irregular glittering speckles on screen.

Repair:

Remove C857, 220uF @16V electrolytic capacitor on main board and replace with 470UF @16V electrolytic Capacitor.

LG RM-32LZ50-

Symptom:

No picture but has sound sound.

Repair:

Remove R60 SMD resistor on Inverter PCB.

LG 26LX1D-

Symptom:

Wavy lines in picture.

Repair:

Replaced C708 and C704 on main board. 100uF @16V SMD electrolytic capacitors.

Emerson LC320EM8AN-

Symptom:

No power,Dead.

Repair:

Replaced shorted diode,type FR202, in PSU. Location, D633.

Safety

A few important tips to remember when working on live circuits.

-Always use an isolation transformer when taking measurements on live equipment.



-Hot and cold ground. Always be aware of the difference between hot and cold ground especially when taking PSU voltage and waveform measurements.

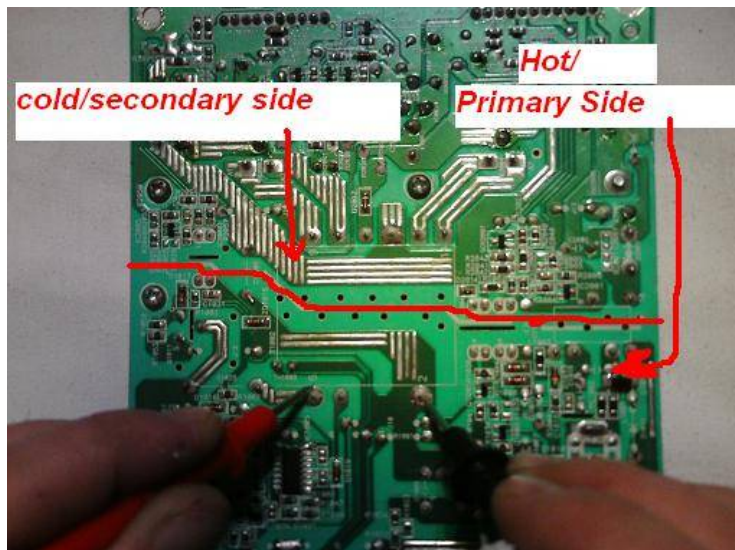

The hot and cold side are usually clearly identified.

-Soldering can be hazardous to your health, remember to be in a well ventilated open area when soldering as smoke inhalation is the main hazard when soldering, besides giving yourself a really good burn. The solder we use on electronics circuits contains rosin, which inhalation of the smoke from can cause asthma.

-Discharging Reservoir/Filter capacitor/s

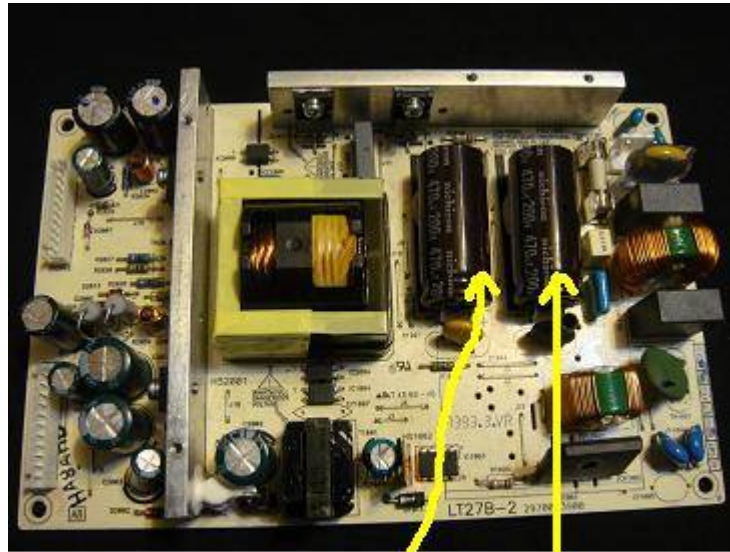

**Reservoir/Primary Filter
Capacitors**

When you remove the PSU board to check components and etc. always discharge the reservoir/primary filter capacitor to avoid getting shocked. I use a 1k ohm 2-5 Watt resistor to discharge the capacitor. Check the DC voltage on the capacitor after discharge just to be safe.

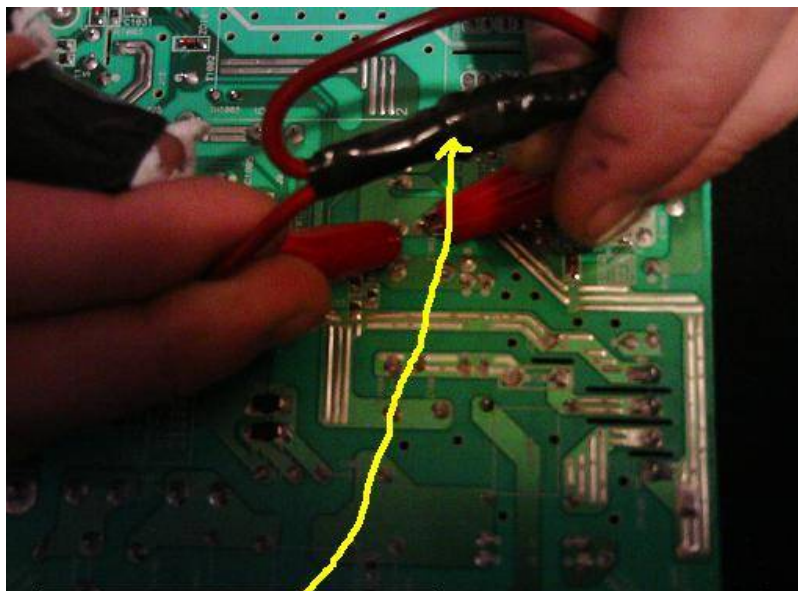

Large Resistor

Discharging Capacitor

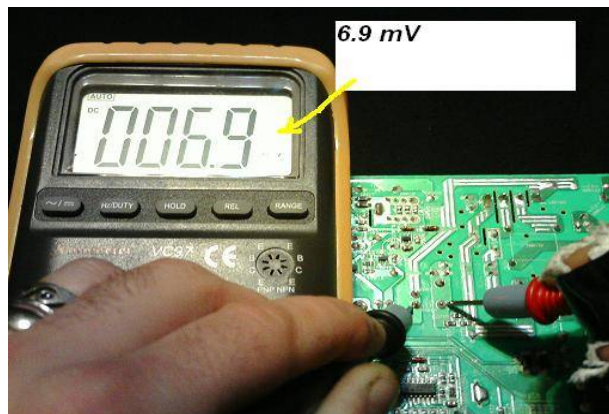

Checking voltage after discharge

-Working on live circuits. Try to never work on live circuits, of course this is not always possible as tests like the voltage testing must be done with the TV on, but always use the most care when working on live circuits as to not hurt or kill yourself and or damage your test equipment and the TV under test

Conclusion

In conclusion I hope you have learned a lot about LCD TVs, how they work and how to troubleshoot and repair them. Obviously I could not even cover or mention all of the electronics circuits involved in the working of an LCD TV as it is way beyond the scope of this book which is based in common repairs and not LCD TV design. The best you could do to further your knowledge is to study the different designs and of course learn as much about electronics as possible from the basics to the advanced from the past to the current. The more you understand and recognize different electronic circuits the easier it will be for you to troubleshoot and repair LCD TVs and any other electronic devices as well. You may even venture into electronic into electronic design someday or get into MCU programming. If you have any further questions or need troubleshooting help email me john@preher-tech.com.

Further Reading

Some good books to further your electronics knowledge.

[Electronic and Electrical Servicing Consumer and Commercial Electronics 2nd edition](#), By Ian Sinclair and John Dunton



[Electronic and Electrical Servicing Consumer and Commercial Electronics Level 3" 2nd edition](#), By Ian Sinclair and John Dunton

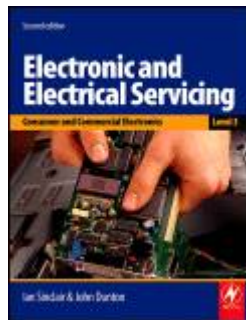

How To Find Burnt Resistor Value, By Jestine Yong

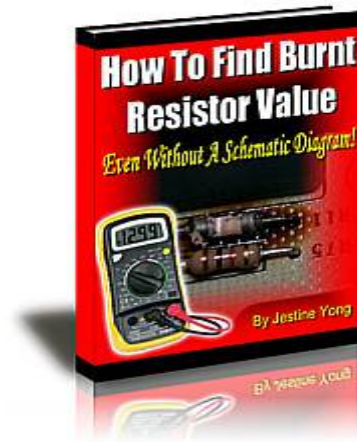

LCD Monitor Repair, By Jestine Yong

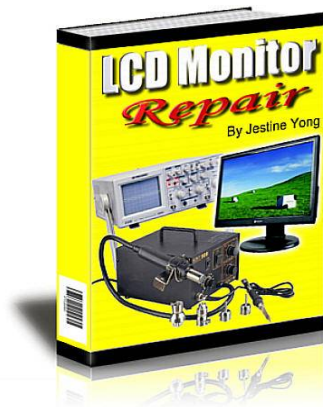

Testing Electronic Components, By Jestine Yong



Troubleshooting & Repairing Switch Mode Power Supplies, By Jestine Yong

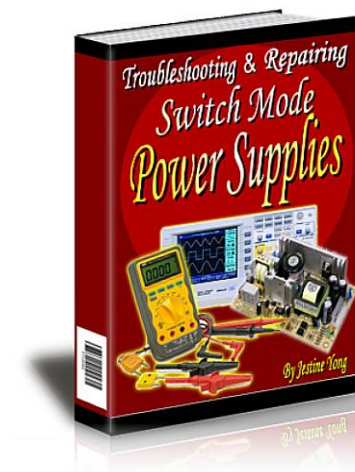

Websites

Some good websites for electronics information.

[LCD TV repair membership site](#)

[Plasma TV repair membership site](#)

[Projection TV repair membership site](#)

[electronicrepairguide.com](#)

[Jestine Yong's Blog](#)

[Preher-Tech Blog](#)

[preher-tech.com](#)

[fastrepairguide.com](#)

Parts Distributors

Here are the parts distributors I most commonly use to get all the parts and boards I need for fixing LCD TVs.

[Suburban](#)

[Encompass](#)

[Shop Jimmy](#)

[MCM](#)

And I also always like looking on ebay, I have bought many TV and electronic components on that site in general with great deals and I have only had great transactions so far. Only buy from reputable dealers.

Places to purchase an ESR meter-

[Electronic Repair Guide](#)(also sells Ring Tester)

[Anatek](#)(also sells Ring Tester)

[EVB](#)

[Radio Devices](#)(the ESR micro, which also checks capacitance)

LCD TV CCFL Tester-

[HR-TL1040](#)

Good place to buy DMM and analogue meters-

[Multimeter Warehouse](#)